

Centro Federal de Educação Tecnológica de Santa Catarina
Departamento Acadêmico de Eletrônica
Conversores Estáticos

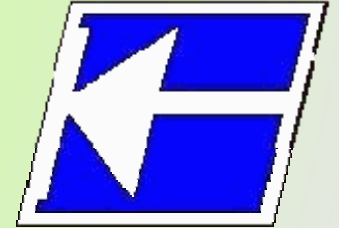

Retificadores Monofásicos

Controlados



Prof. Clóvis Antônio Petry.

Florianópolis, agosto de 2008.

Bibliografia para esta aula

Capítulo 6: Retificadores monofásicos controlados

1. Retificador monofásico de meia onda;

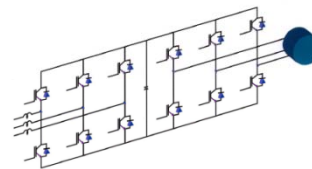
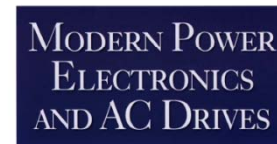

BIMAL K. BOSE

www.cefetsc.edu.br/~petry

Nesta aula

Retificadores monofásicos controlados:

1. Introdução;
2. Retificador monofásico de meia onda:
 - Carga resistiva;
 - Carga RL;
 - Carga RL e diodo de roda livre;
 - Carga LE;
 - Uso do transformador;
 - Fator de potência.

Retificador monofásico de meia onda

Carga resistiva pura:

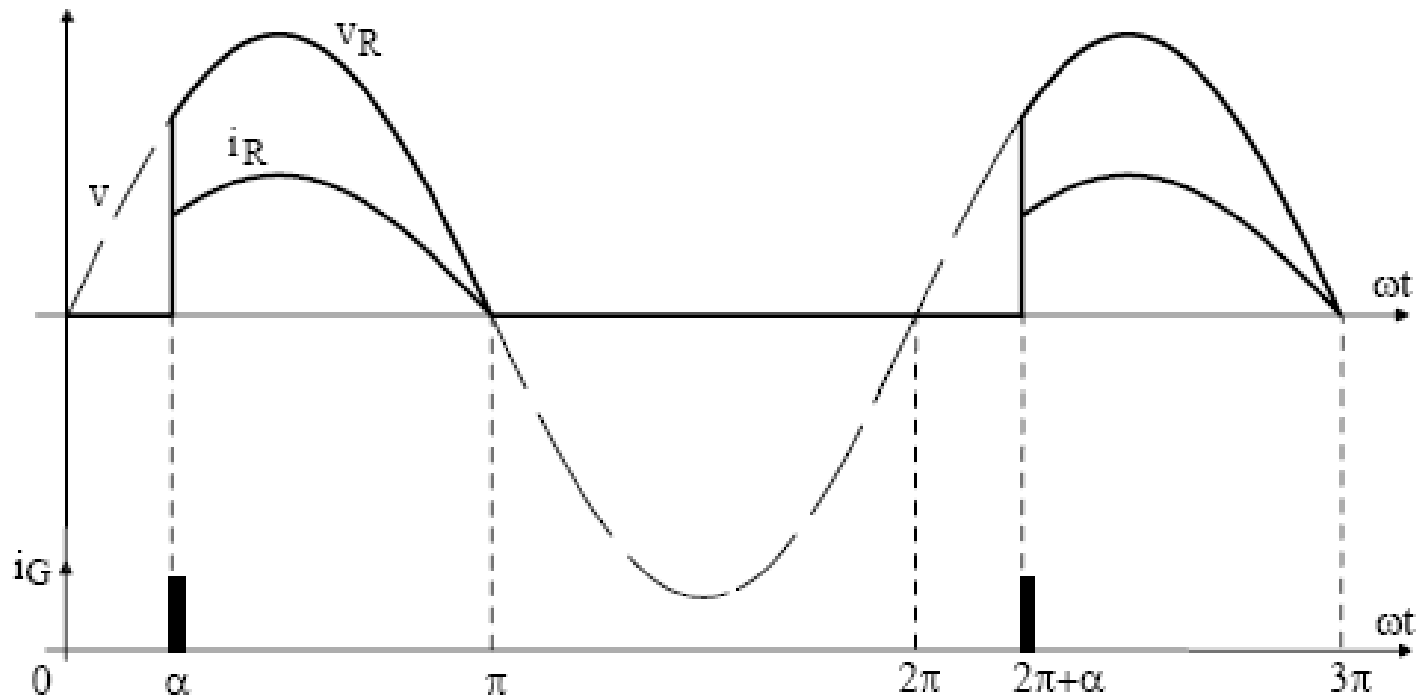
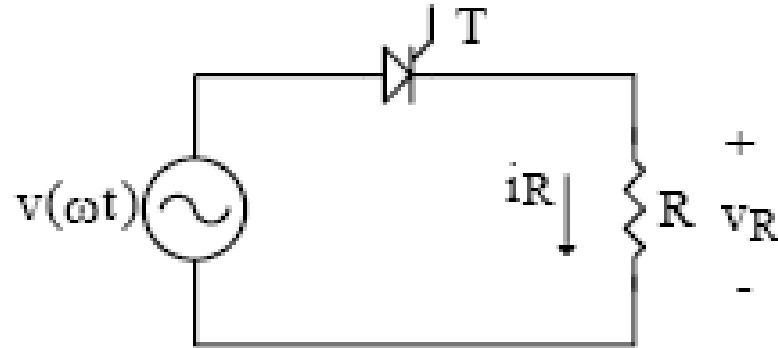

Retificador monofásico de meia onda

Carga resistiva pura:

Tensão média na carga:

$$v(\omega t) = \sqrt{2} \cdot V_o \cdot \text{sen}(\omega t)$$

$$V_{Lmed} = \frac{1}{2\pi} \int_{\alpha}^{\pi} \sqrt{2} \cdot V_o \cdot \text{sen}(\omega t) \cdot d(\omega t)$$

$$V_{Lmed} = \frac{\sqrt{2} \cdot V_o}{2\pi} [1 + \cos(\alpha)]$$

$$V_{Lmed} = 0,225 \cdot V_o [1 + \cos(\alpha)]$$

$$\circ \alpha = 0 \Rightarrow V_{Lmed} = 0,45 \cdot V_o$$

$$\circ \alpha = 180^\circ \Rightarrow V_{Lmed} = 0$$

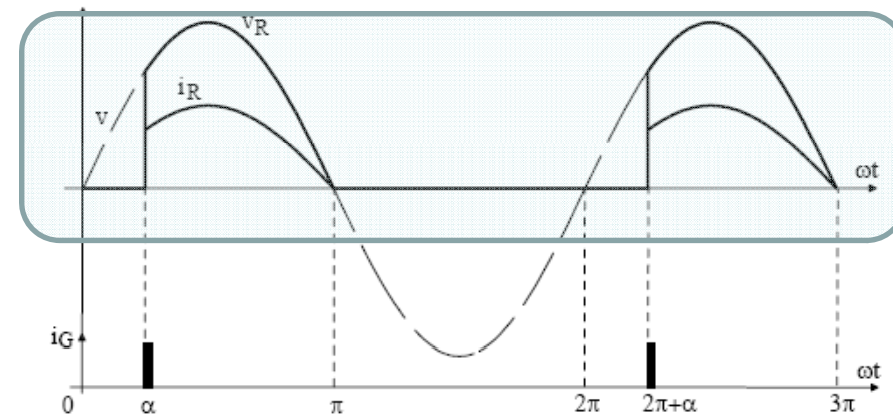

Retificador monofásico de meia onda

Carga resistiva pura:

Corrente média na carga:

$$I_{Lmed} = \frac{1}{2\pi} \int_{\alpha}^{\pi} \frac{\sqrt{2} \cdot V_o}{R} \cdot \text{sen}(\omega t) \cdot d(\omega t)$$

$$I_{Lmed} = \frac{0,225 \cdot V_o}{R} [1 + \cos(\alpha)] = \frac{V_{Lmed}}{R}$$

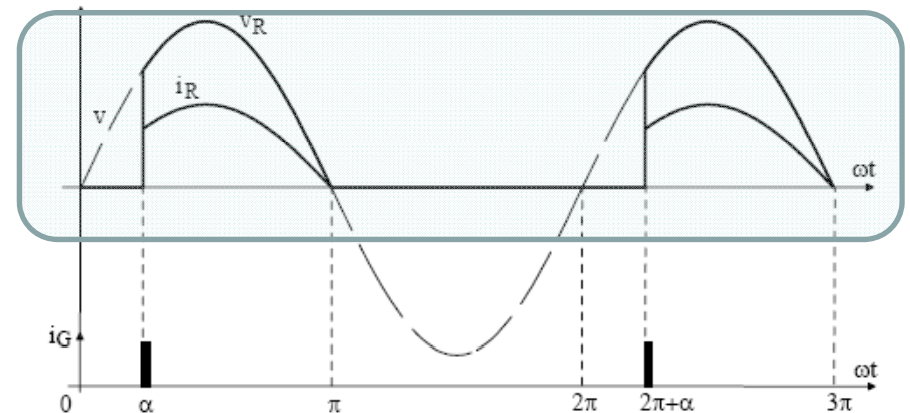

Retificador monofásico de meia onda

Carga resistiva pura:

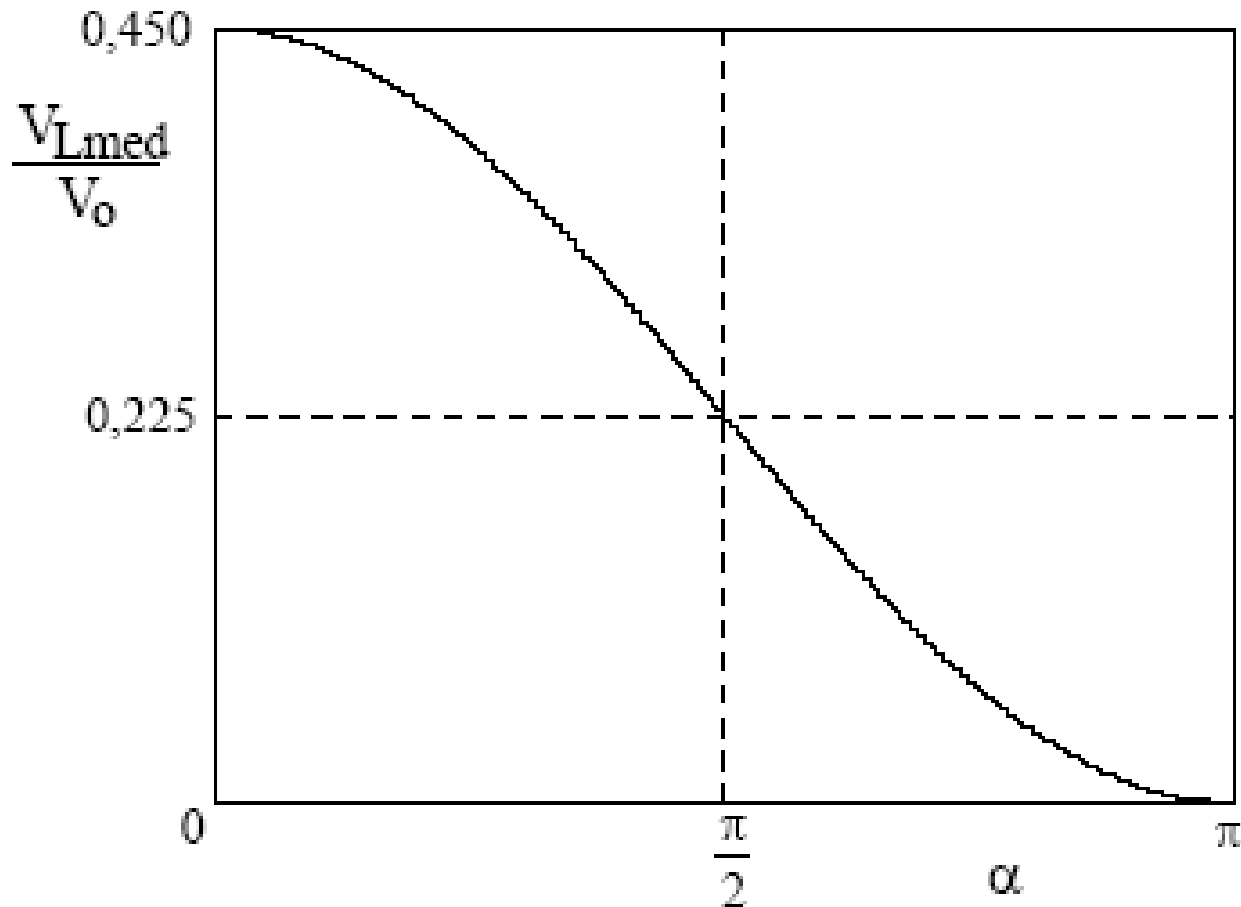

Característica de saída

Retificador monofásico de meia onda

Carga resistiva pura:

Corrente eficaz na carga:

$$I_{Lef} = \sqrt{\frac{1}{2\pi} \int_{\alpha}^{\pi} \left(\frac{\sqrt{2} \cdot V_o}{R} \text{sen}(\omega t) \right)^2 \cdot d(\omega t)}$$

$$I_{Lef} = \frac{V_o}{R} \sqrt{\frac{1}{2} - \frac{\alpha}{2\pi} + \frac{\text{sen}(2\alpha)}{4\pi}}$$

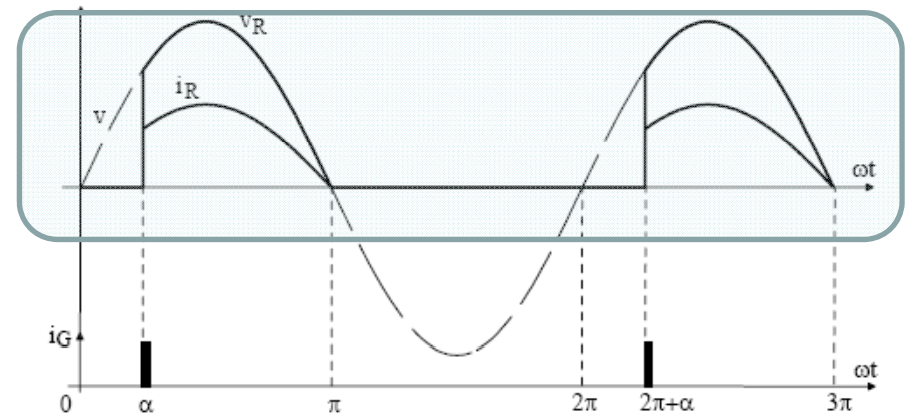

Retificador monofásico de meia onda

Carga resistiva pura:

Se $\alpha=0$, idêntico ao retificador a diodos

Fator de potência:

$$FP = \frac{P}{S}$$

$$\text{Fator de potência} = \frac{\text{Potência ativa}}{\text{Potência aparente}}$$

$$S = V_{ef} \cdot I_{ef}$$

$$P = R \cdot I_{ef}^2$$

$$P = V_{ef} \cdot I_{ef} \cdot \cos(\theta)$$



Fator de deslocamento

$$FP = \frac{1}{\sqrt{2}} \cong 0,707$$

Retificador monofásico de meia onda

Carga resistiva pura:

Se $\alpha=0$, idêntico ao retificador a diodos

Eficiência do retificador:

$$P_{AC} = V_{ef} \cdot I_{ef}$$

$$P_{AC} = V_o \cdot \frac{V_o}{\sqrt{2} \cdot R} = \frac{V_o^2}{\sqrt{2} \cdot R}$$

$$P_{DC} = V_{Lmed} \cdot I_{Lmed}$$

$$P_{DC} = \frac{\sqrt{2} \cdot V_o}{\pi} \cdot \frac{\sqrt{2} \cdot V_o}{\pi \cdot R} = \frac{2 \cdot V_o^2}{\pi^2 \cdot R}$$

$$\eta = \frac{P_{DC}}{P_{AC}} = \frac{\frac{2 \cdot V_o^2}{\pi^2 \cdot R}}{\frac{V_o^2}{\sqrt{2} \cdot R}}$$

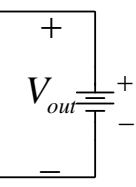
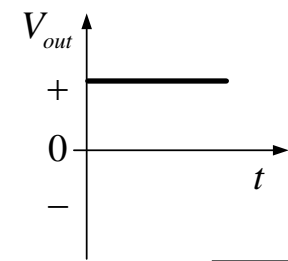
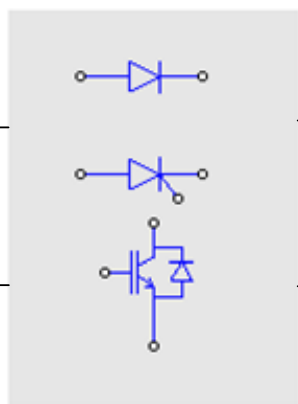
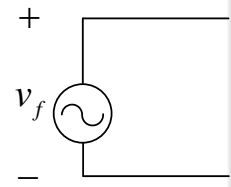
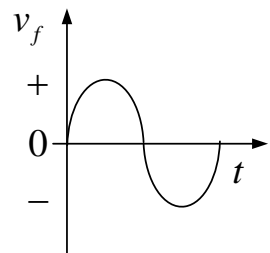

$$\eta = \frac{2\sqrt{2}}{\pi^2} \cong 0,286$$

Retificador monofásico de meia onda

Carga resistiva pura:

Se $\alpha=0$, idêntico ao retificador a diodos

Eficiência do retificador, se for usado um transformador:

$$\eta = \frac{2\sqrt{2}}{\pi^2} \cong 0,286$$

$$S_{trafo} = \frac{P_{AC}}{P_{DC}} = \frac{1}{\eta} = \frac{\pi^2}{2\sqrt{2}} \cong 3,489$$

Significa o uso de um transformador 3,5 vezes maior.

Retificador monofásico de meia onda

Carga resistiva pura:

Ângulo de condução do tiristor:

$$\alpha \leq \beta \leq 180^\circ$$

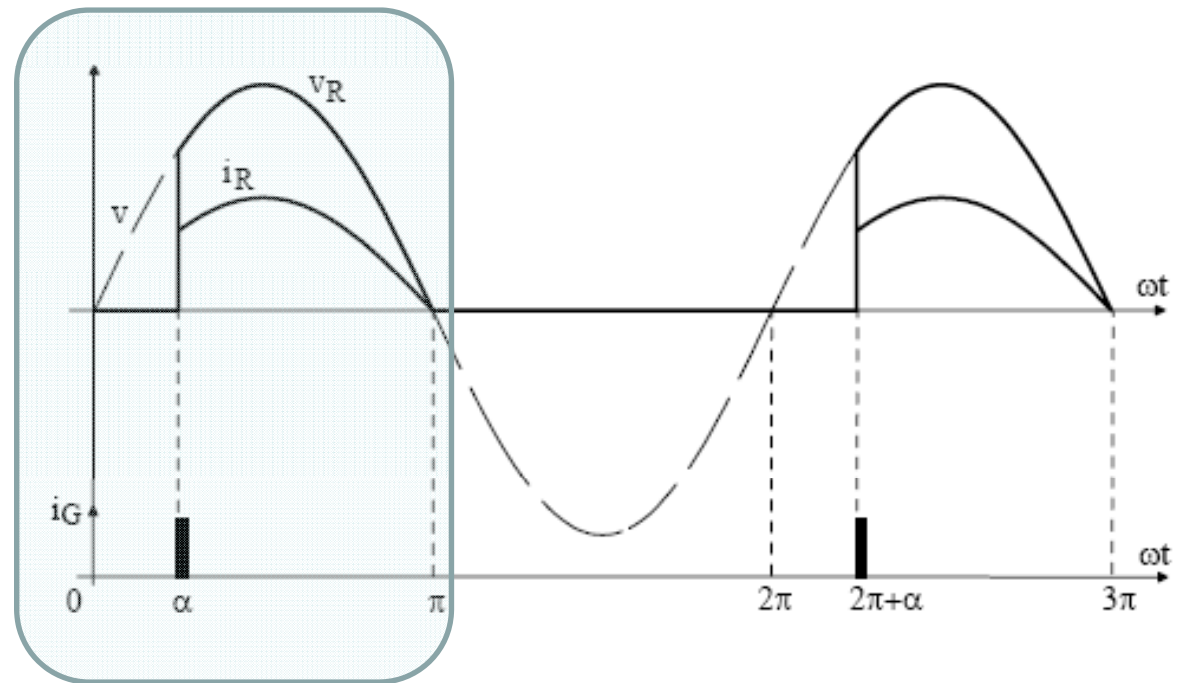

Retificador monofásico de meia onda

Carga RL:

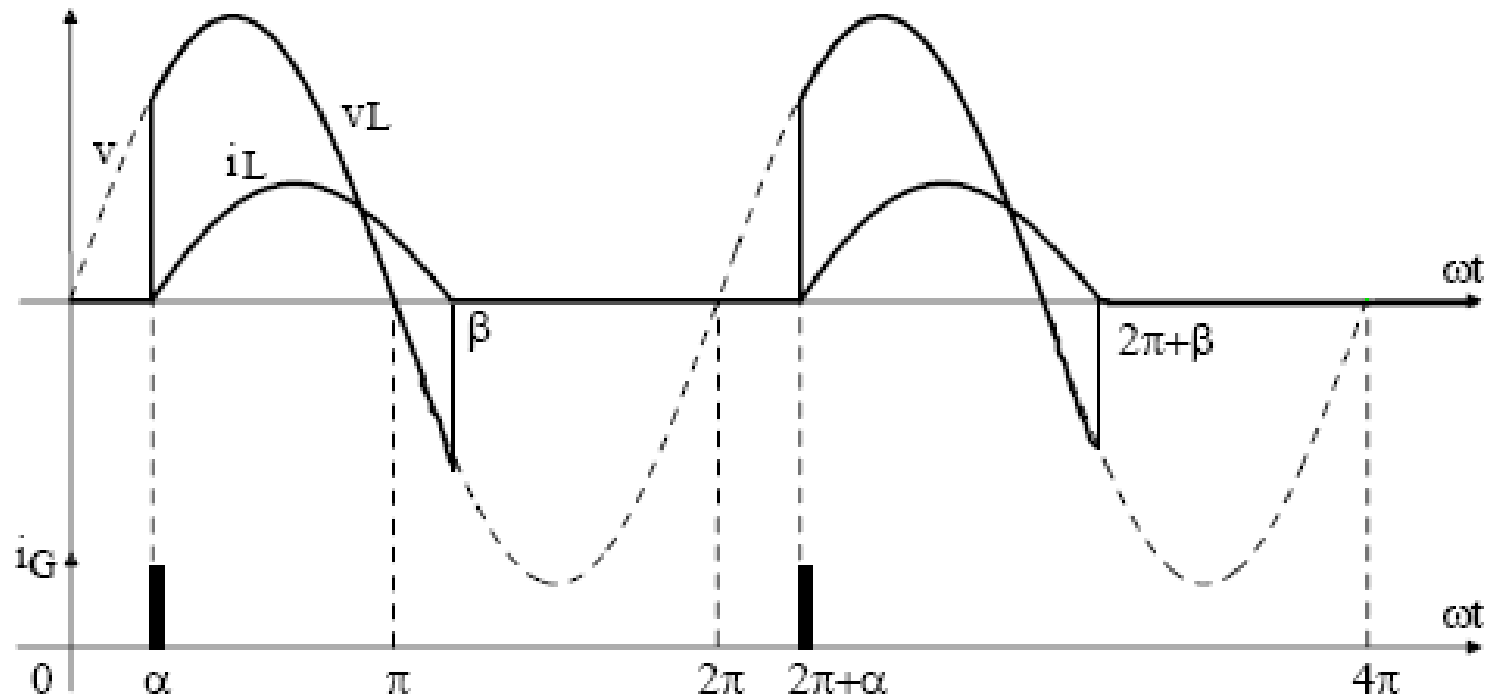
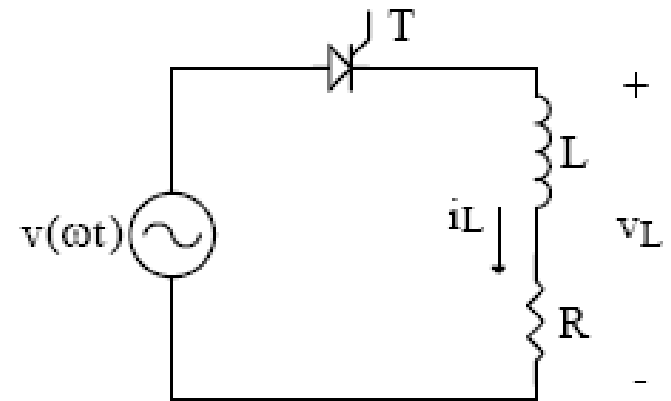

Retificador monofásico de meia onda

Carga RL:

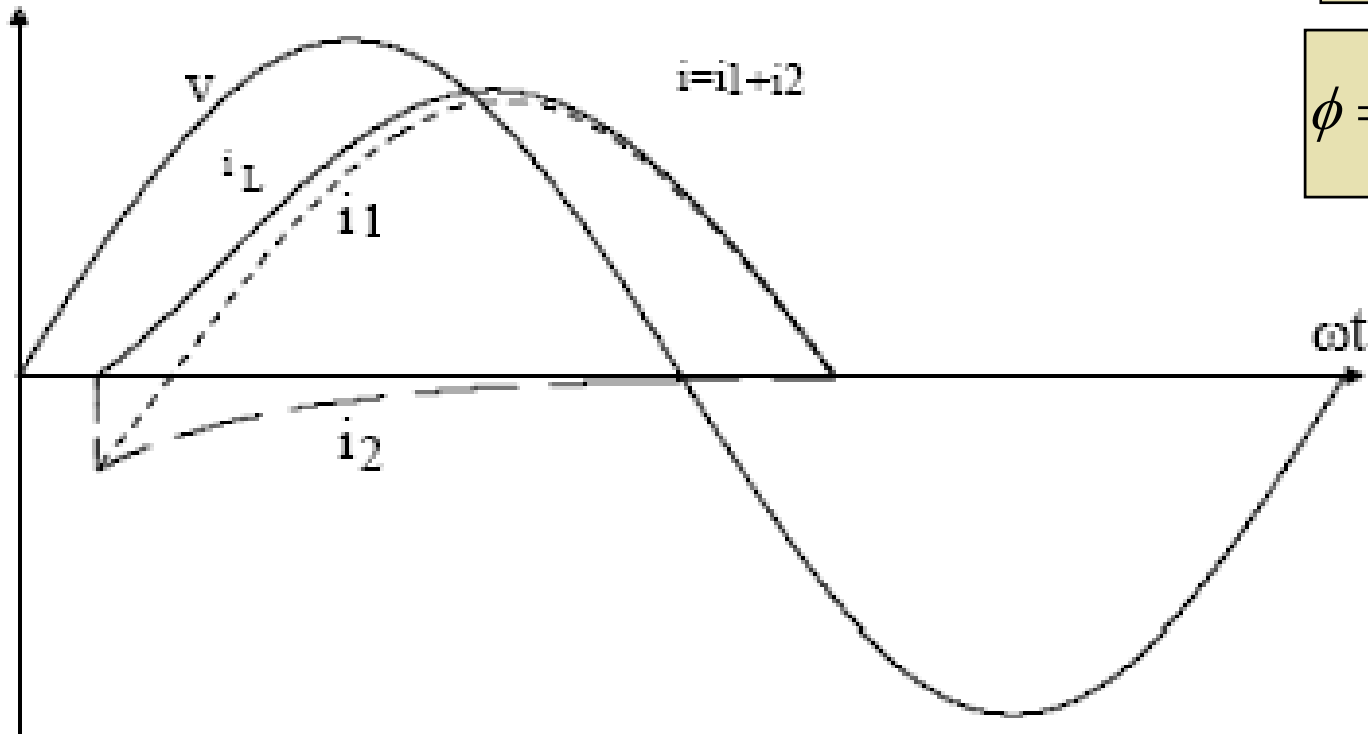

$$\operatorname{tg}(\phi) = \frac{\omega \cdot L}{R}$$

$$\phi = \operatorname{tg}^{-1}\left(\frac{\omega \cdot L}{R}\right)$$

$$\alpha < \phi$$

Retificador monofásico de meia onda

Carga RL:

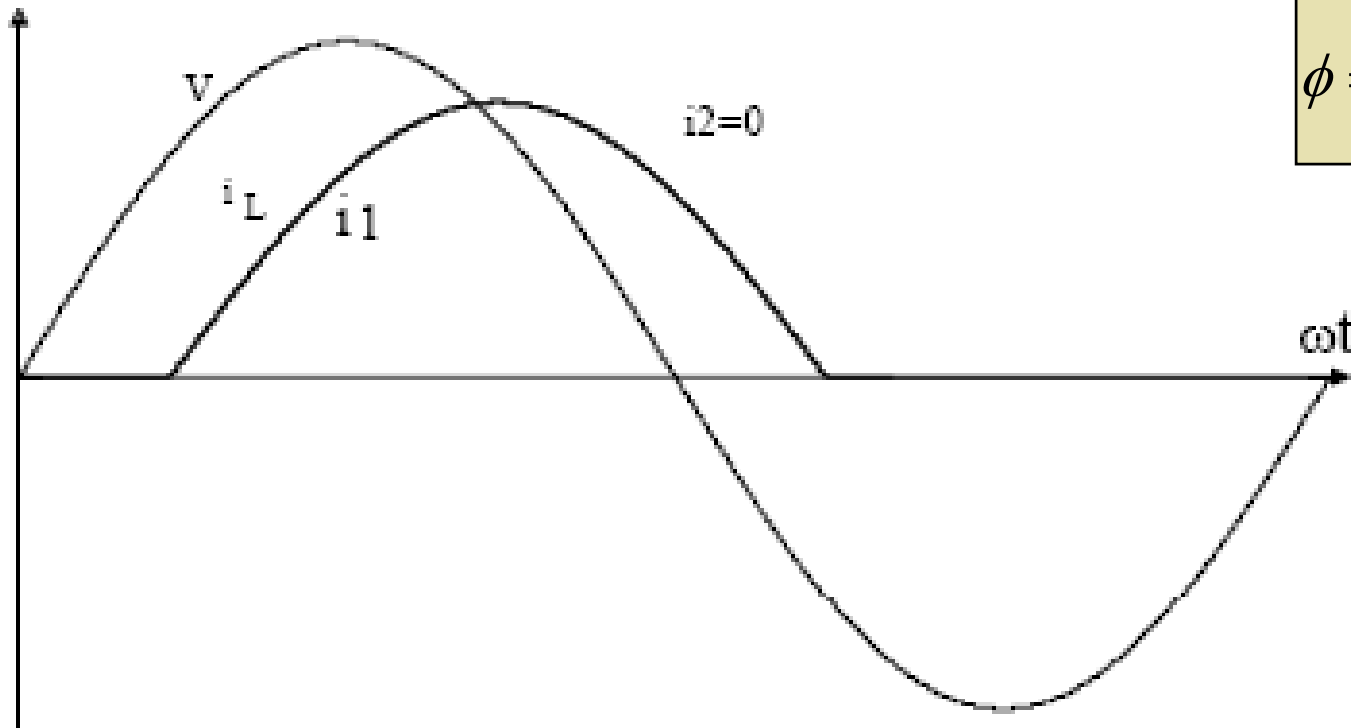

$$tg(\phi) = \frac{\omega \cdot L}{R}$$

$$\phi = tg^{-1}\left(\frac{\omega \cdot L}{R}\right)$$

$$\alpha = \phi$$

Retificador monofásico de meia onda

Carga RL:

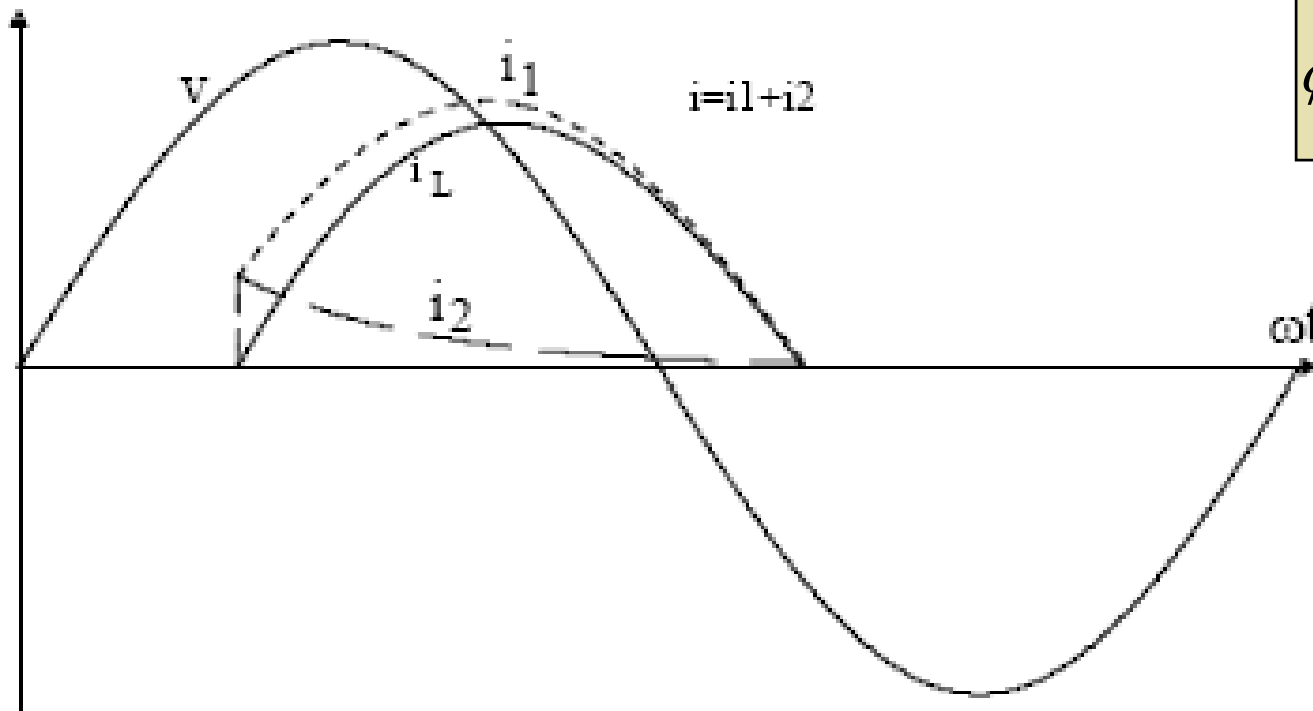

$$\operatorname{tg}(\phi) = \frac{\omega \cdot L}{R}$$

$$\phi = \operatorname{tg}^{-1}\left(\frac{\omega \cdot L}{R}\right)$$

$$\alpha > \phi$$

Retificador monofásico de meia onda

Carga RL:

Tensão média na carga:

$$v(\omega t) = \sqrt{2} \cdot V_o \cdot \text{sen}(\omega t)$$

$$V_{Lmed} = \frac{1}{2\pi} \int_{\alpha}^{\beta} \sqrt{2} \cdot V_o \cdot \text{sen}(\omega t) \cdot d(\omega t)$$

$$V_{Lmed} = 0,225 \cdot V_o [\cos(\alpha) - \cos(\beta)]$$

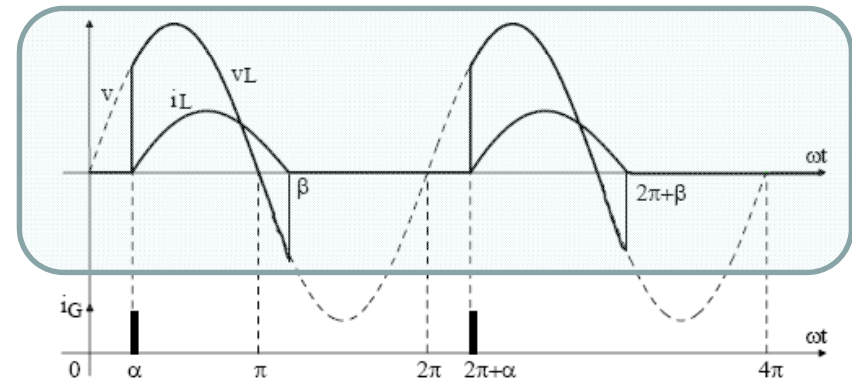

Retificador monofásico de meia onda

Carga RL:

Corrente média na carga:

$$I_{Lmed} = \frac{0,225 \cdot V_o}{R} (\cos(\alpha) - \cos(\beta)) = \frac{V_{Lmed}}{R}$$

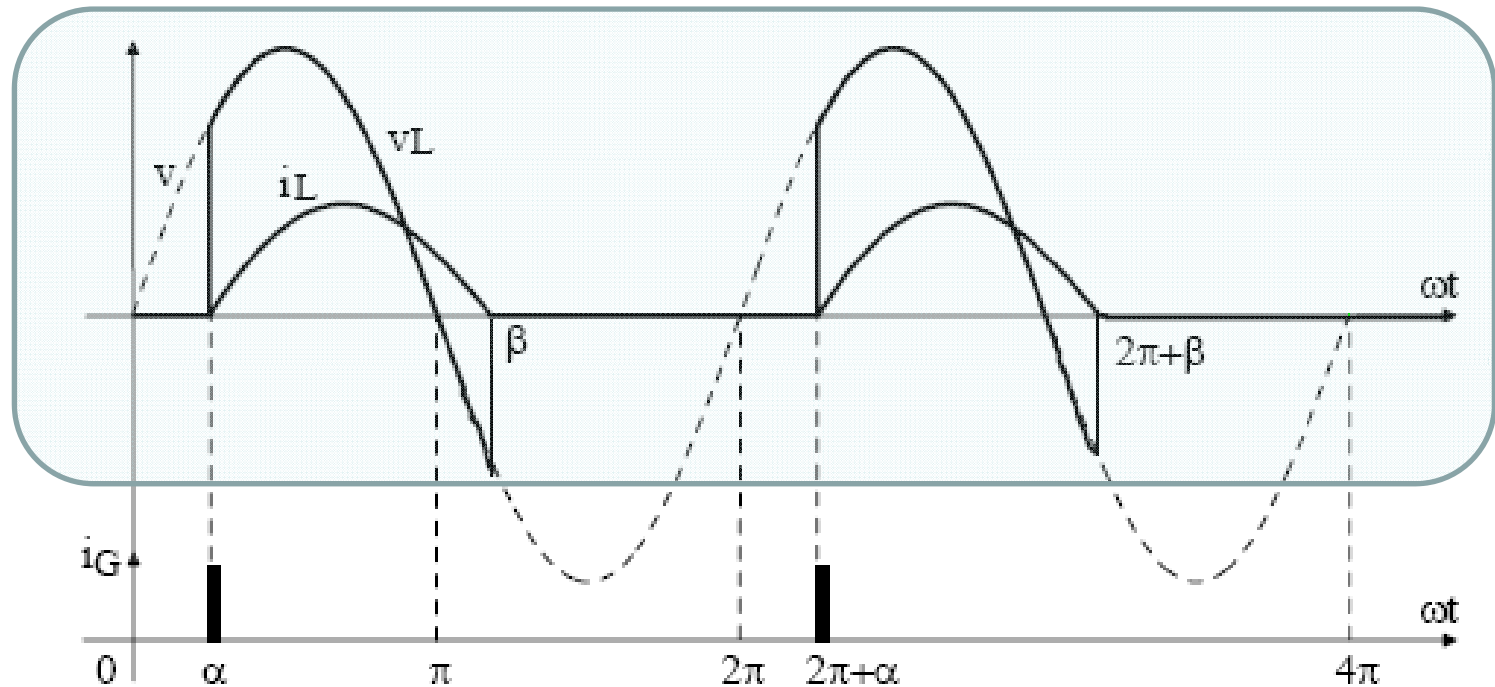

Retificador monofásico de meia onda

Carga RL:

$$\hat{\text{Ângulo de extinção}} (\beta): 0 = \text{sen}(\beta - \phi) - \text{sen}(\alpha - \phi) \cdot e^{-\frac{R}{\omega L}(\beta - \alpha)}$$

Ângulo de condução (γ):

$$\gamma = \beta - \alpha$$

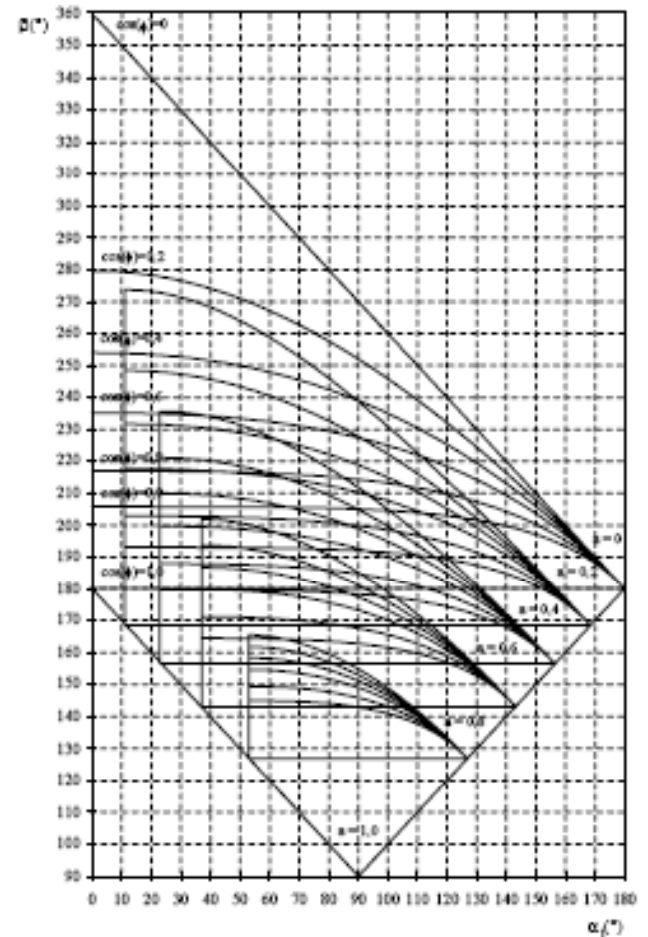

Ábaco de Puschlowski

Retificador monofásico de meia onda

Carga RL:

Corrente média normalizada:

$$I_{md} = \frac{R}{0,225 \cdot V_o} I_{Lmed}$$

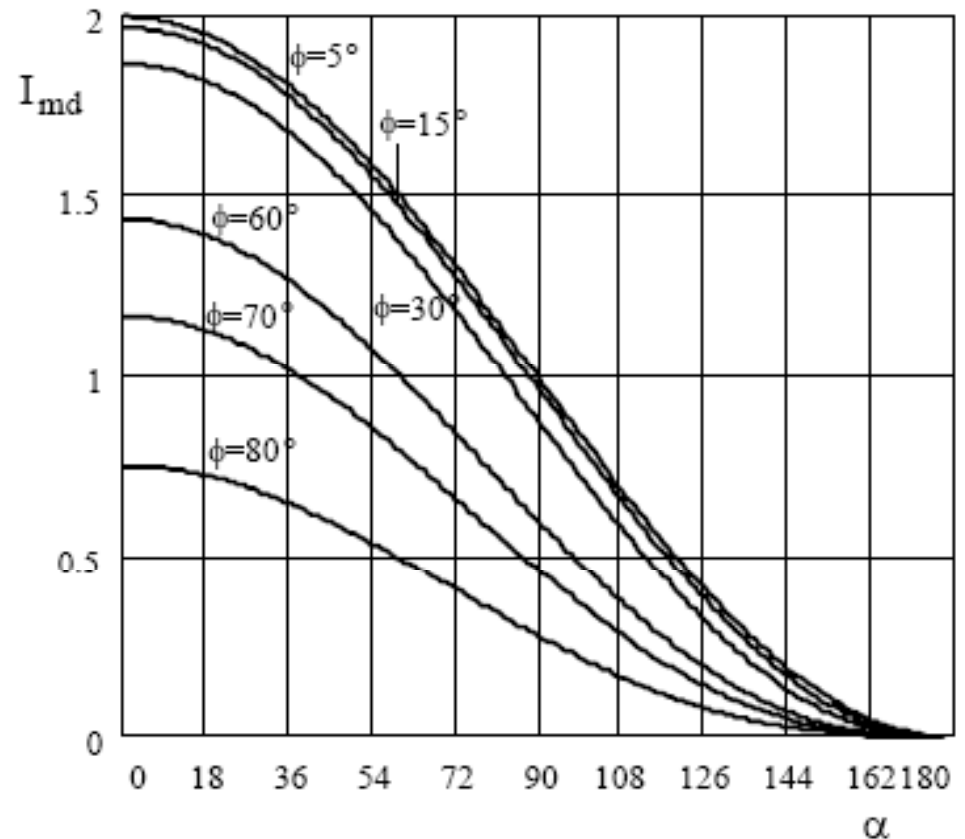

Retificador monofásico de meia onda

Carga RL:

Ângulo de condução do tiristor:

$$\alpha \leq \gamma \leq \beta$$

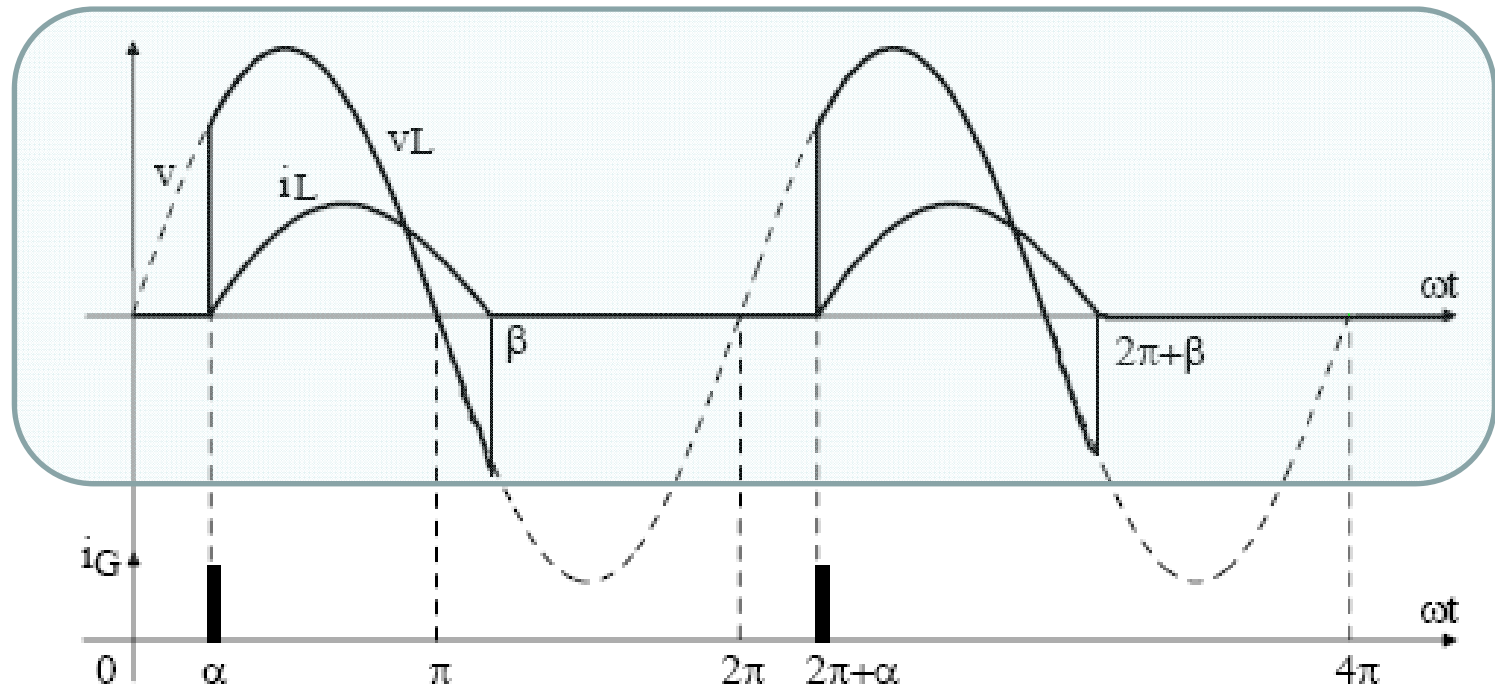

Retificador monofásico de meia onda

Carga RL com diodo de roda-livre:

Circuito do retificador:

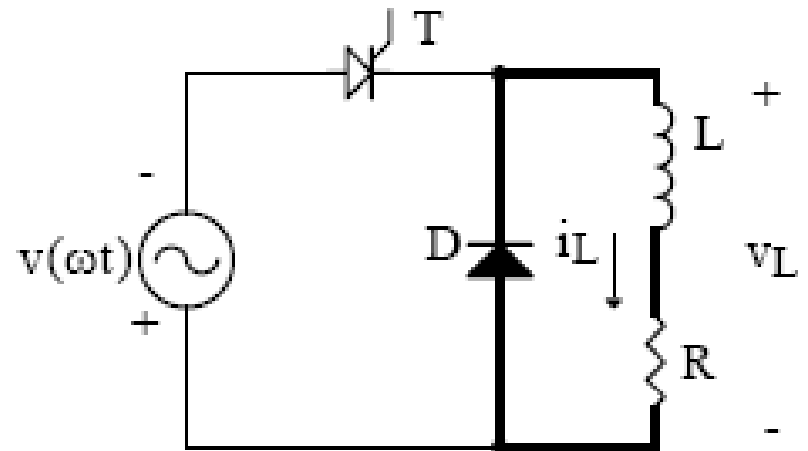
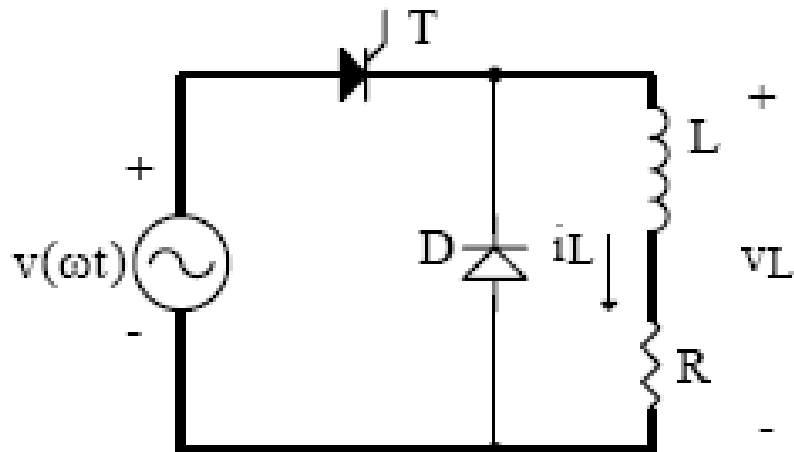
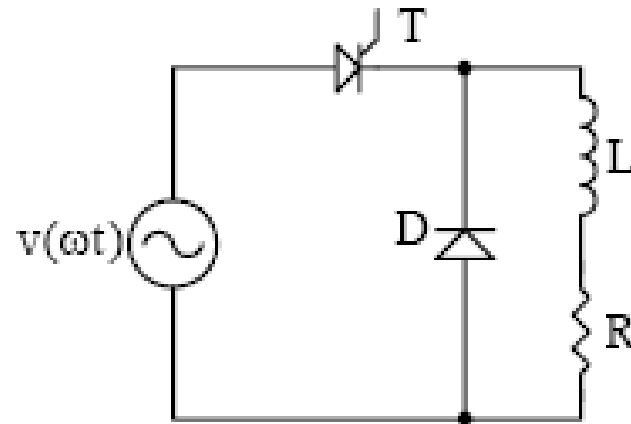

Etapas de funcionamento

Retificador monofásico de meia onda

Carga RL com diodo de roda-livre:

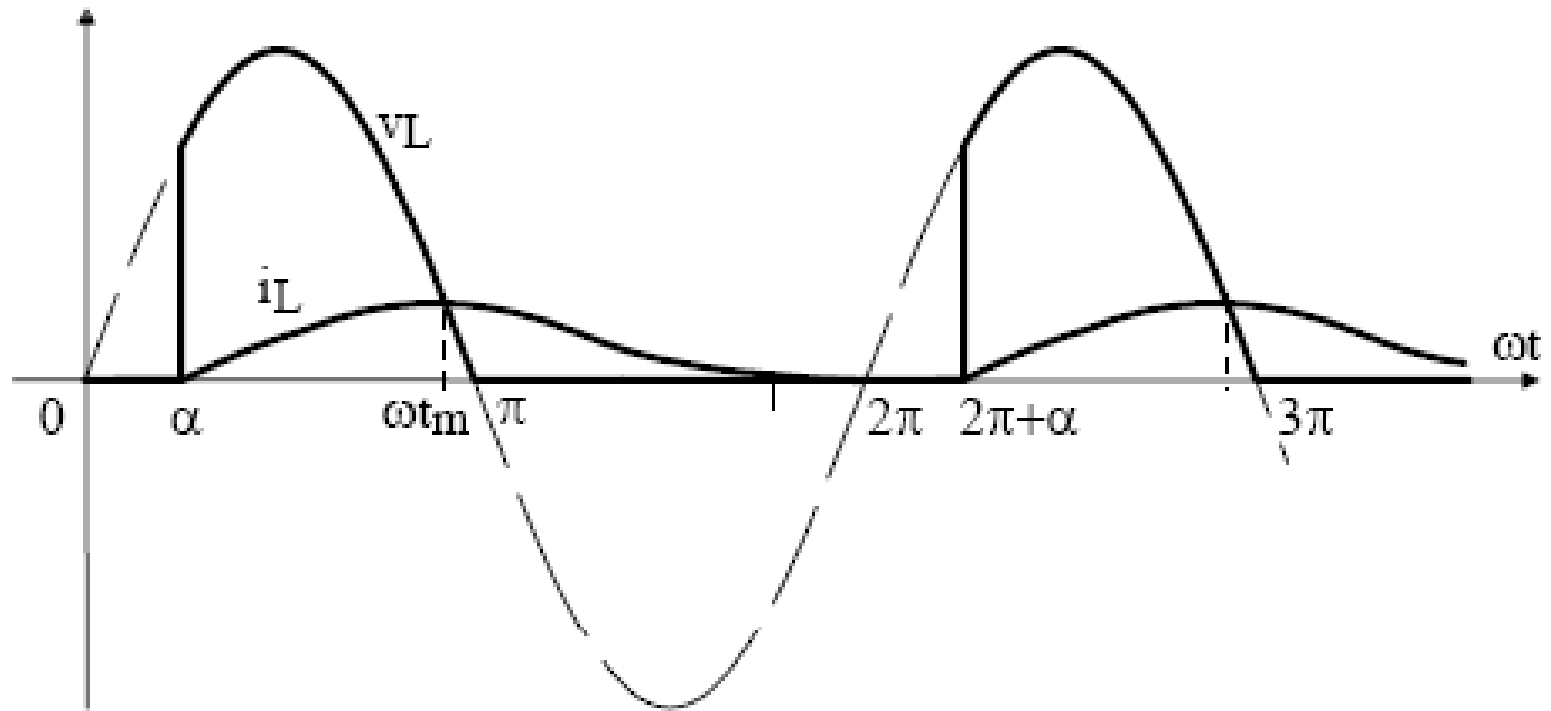

Retificador monofásico de meia onda

Carga RL com diodo de roda-livre:

Tensão média na carga:

$$V_{Lmed} = 0,225 \cdot V_o [1 + \cos(\alpha)]$$

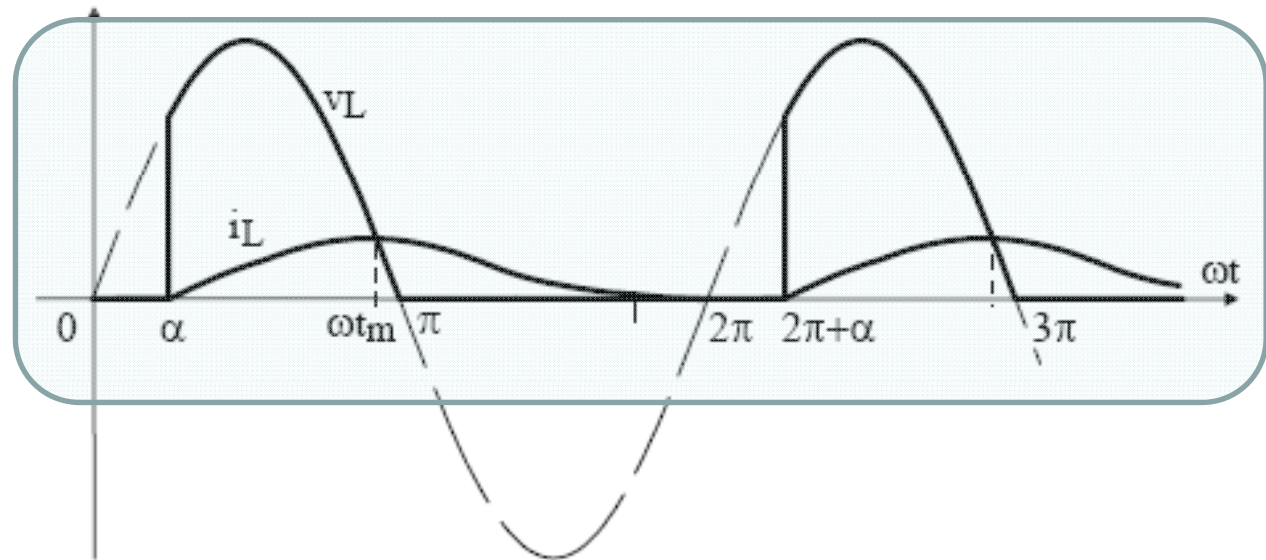

Retificador monofásico de meia onda

Carga LE:

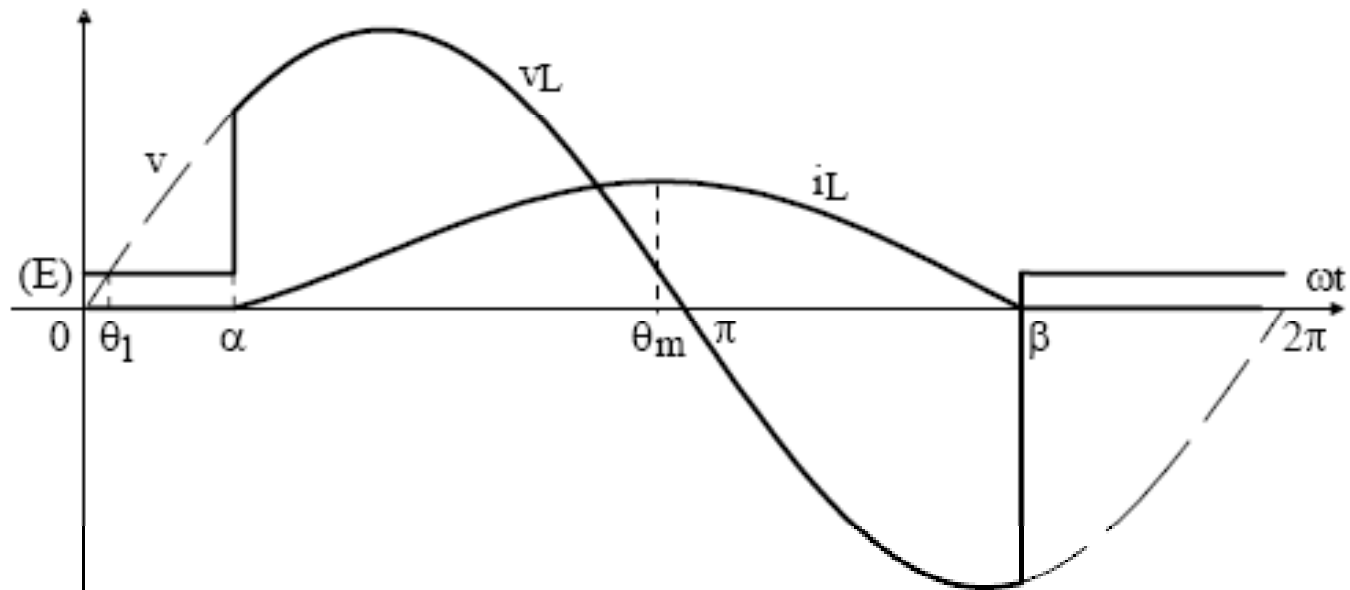
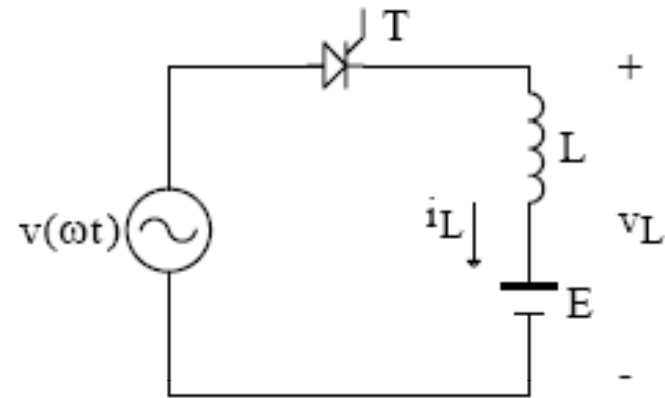

Próxima aula

Conversores CA-CC:

1. Retificadores monofásicos controlados de onda completa.

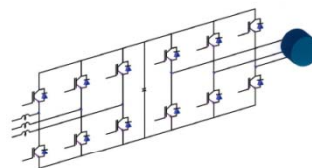

BIMAL K. BOSE