

Instituto Federal de Educação, Ciência e Tecnologia de Santa Catarina

Departamento Acadêmico de Eletrônica

Eletrônica de Potência



Conversores CC-CC Não-Isolados (Princípio de Funcionamento)

Prof. Clovis Antonio Petry.

Florianópolis, novembro de 2015.

Capítulo 9 - Conversores cc-cc:

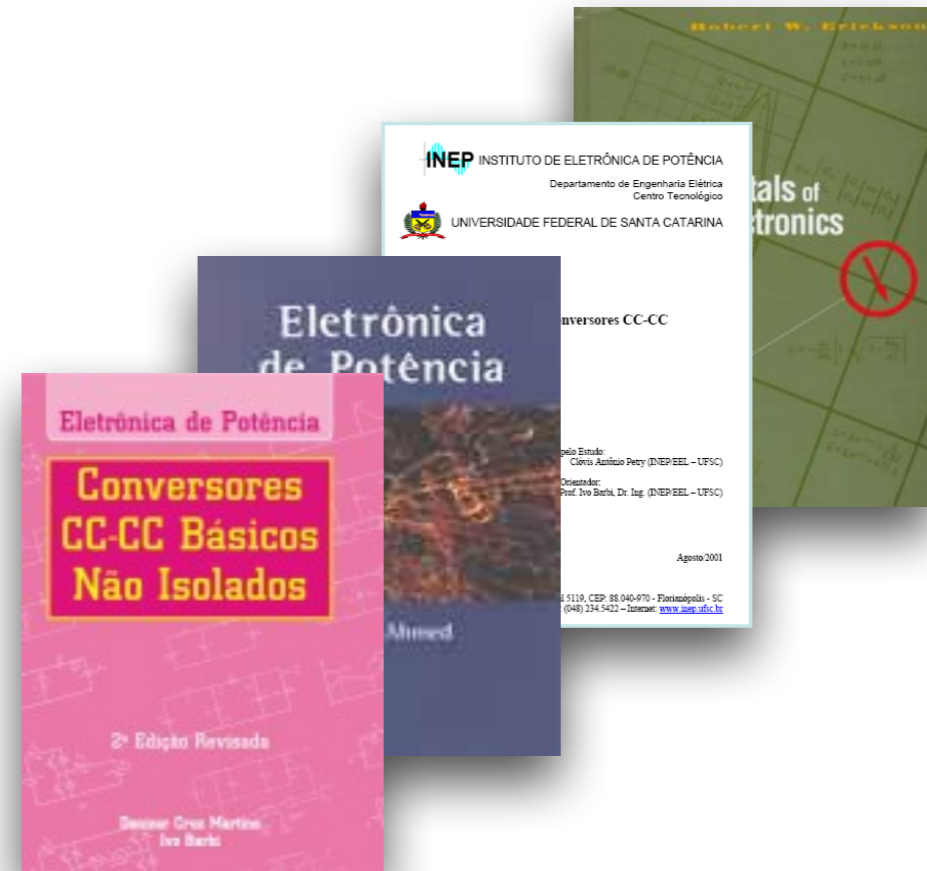

- Introdução aos conversores cc-cc.

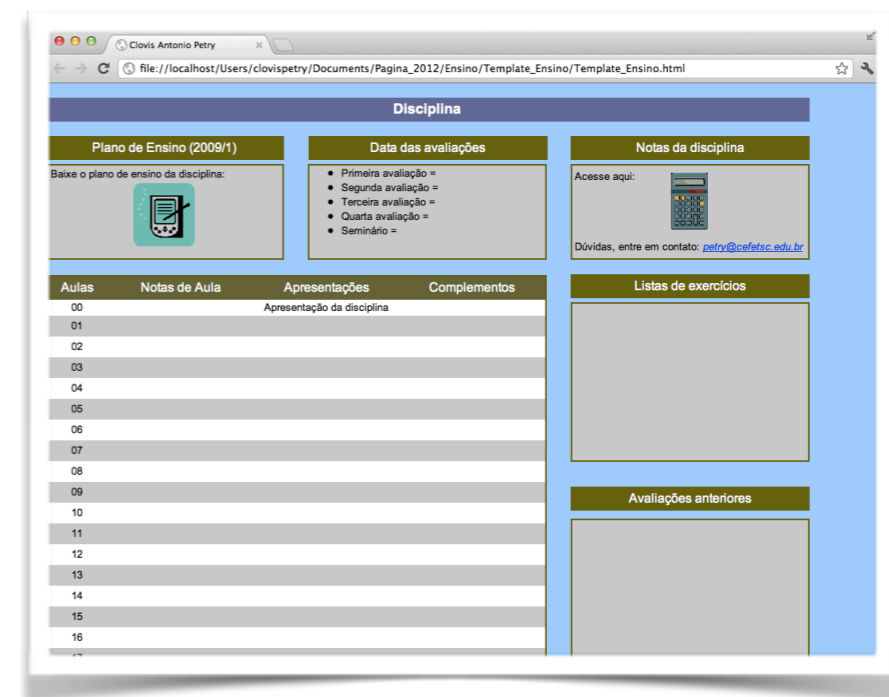

www.ProfessorPetry.com.br



A screenshot of a web browser showing a course page for 'Disciplina'. The page is titled 'Disciplina' and contains several sections:

- Plano de Ensino (2009/1)**: Baixe o plano de ensino da disciplina: 
- Data das avaliações**:
 - Primeira avaliação =
 - Segunda avaliação =
 - Terceira avaliação =
 - Quarta avaliação =
 - Seminário =
- Notas da disciplina**: Acesse aqui: 
Dúvidas, entre em contato: petry@cefetac.edu.br
- Aulas**: A table with columns for 'Aulas', 'Notas de Aula', 'Apresentações', and 'Complementos'. The rows are numbered 00 to 16.
- Listas de exercicios**: A section for exercise lists.
- Avaliações anteriores**: A section for previous evaluations.

Nesta Aula

Conversores cc-cc:

- Introdução;
- Princípio geral;
- Exercícios.

Introdução

Exemplo: Como realizar esta conversão?

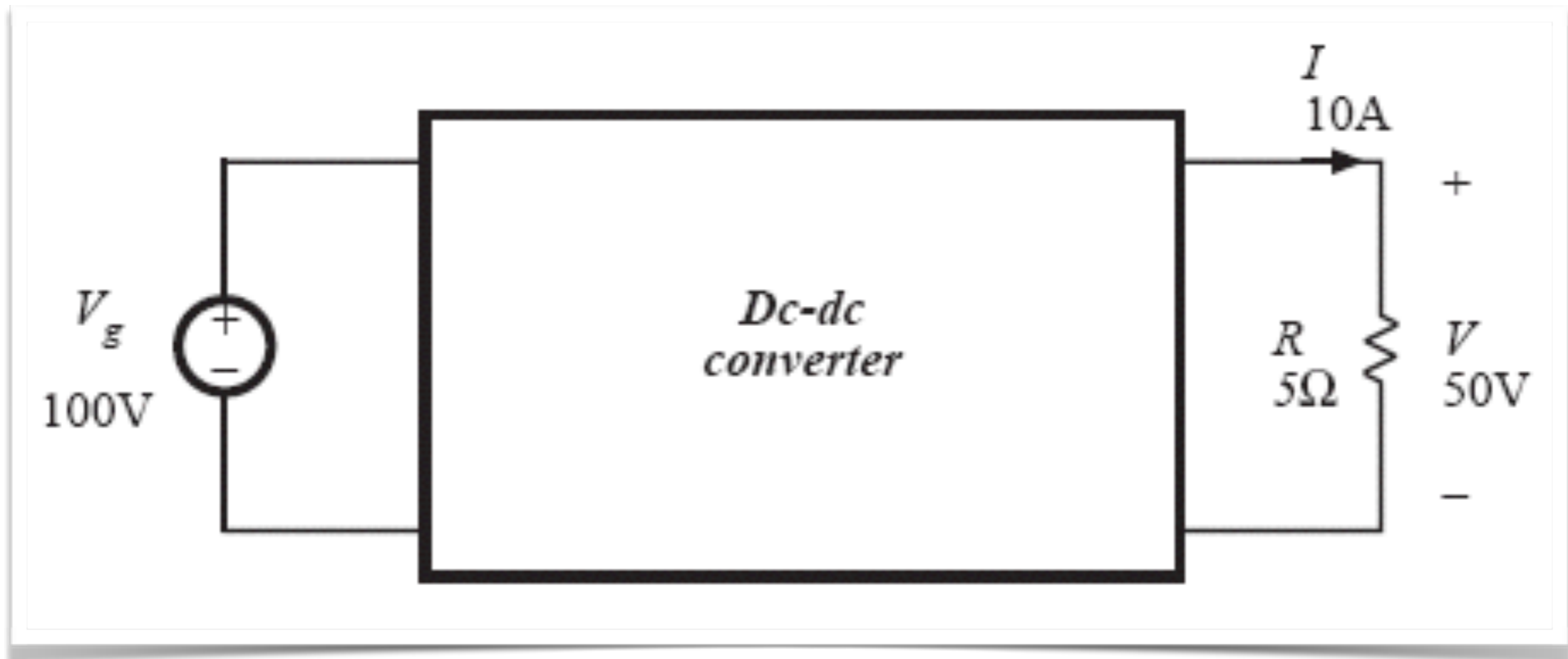

Introdução

Exemplo: Como realizar esta conversão?

Usando resistores.

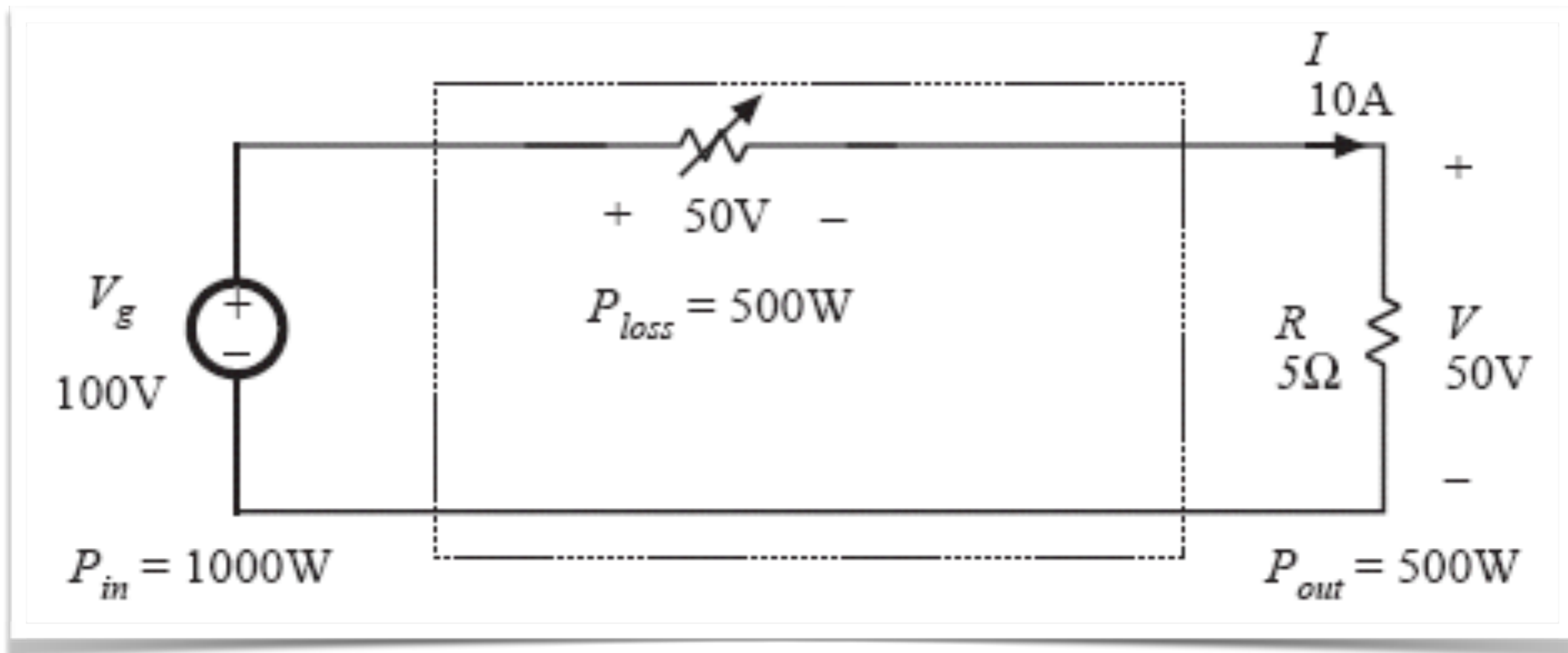

Introdução

Exemplo: Como realizar esta conversão?

Usando reguladores lineares.

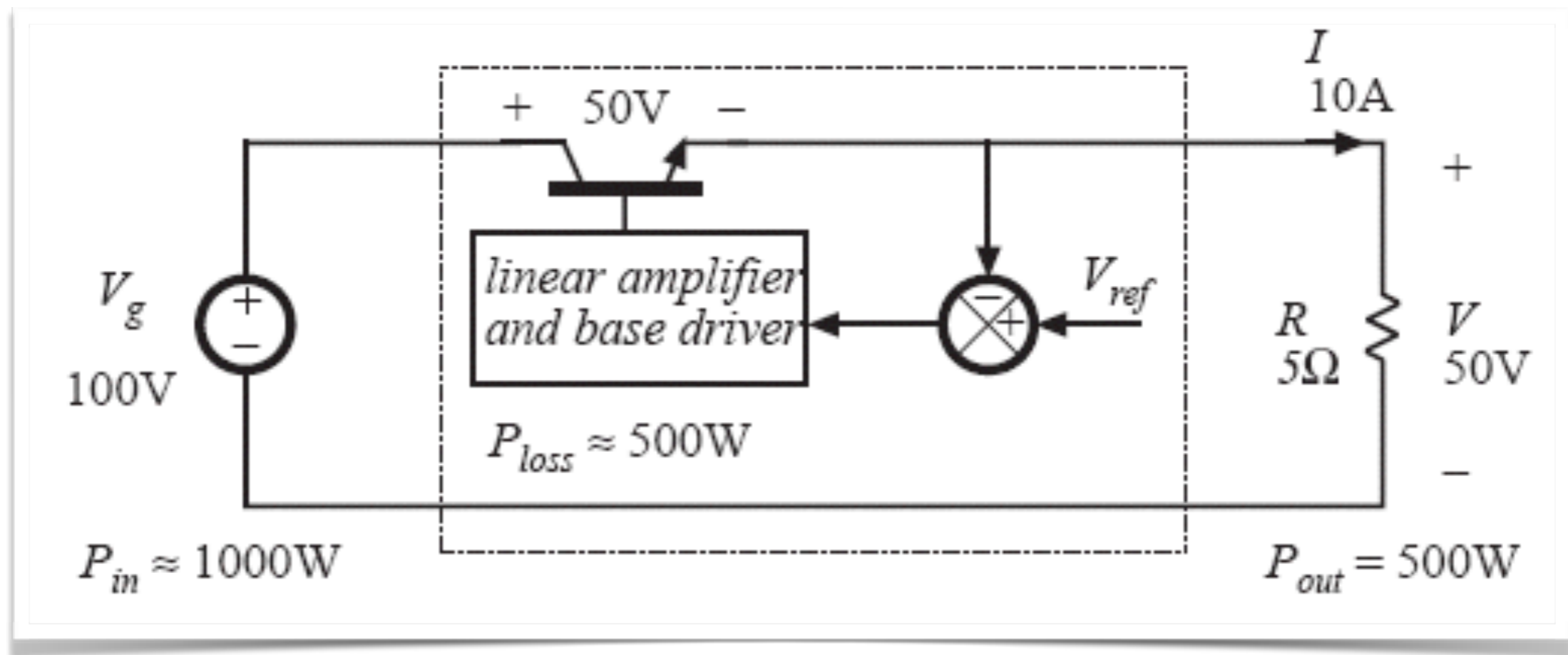

Princípio Geral

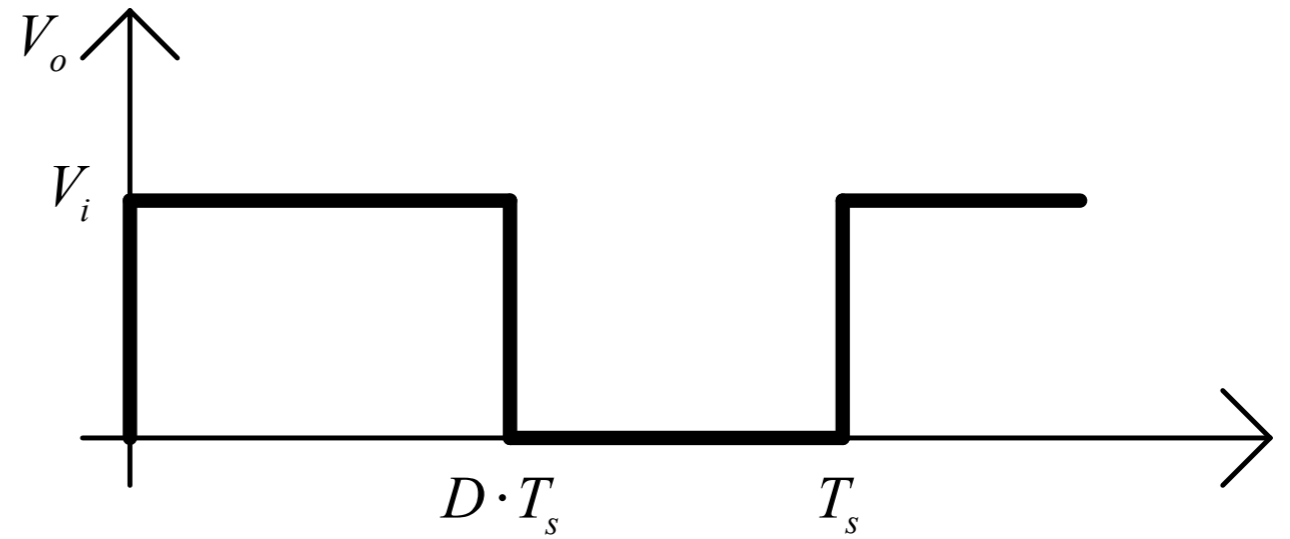
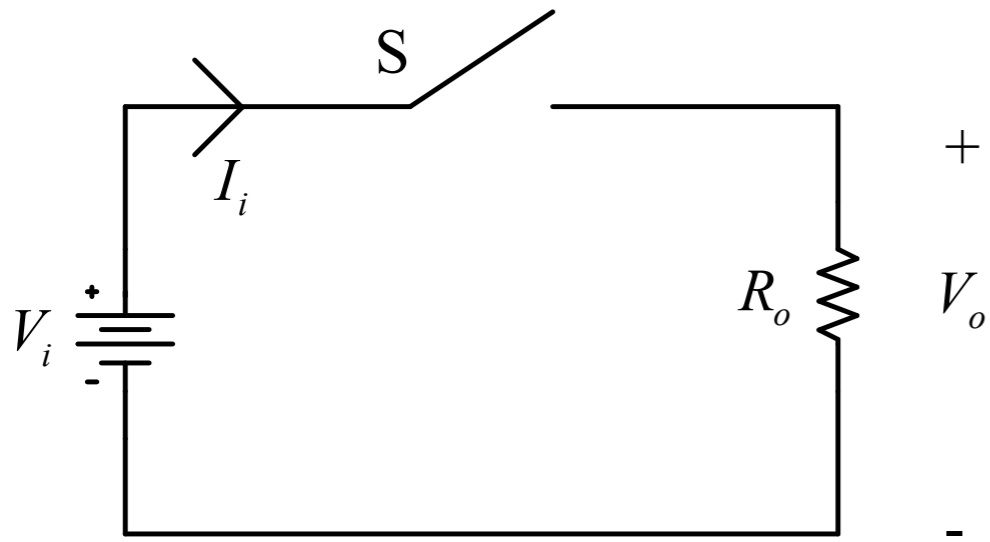

$$T_s = \frac{1}{F_s}$$

$$D = \frac{T_{on}}{T_s}$$

Princípio Geral

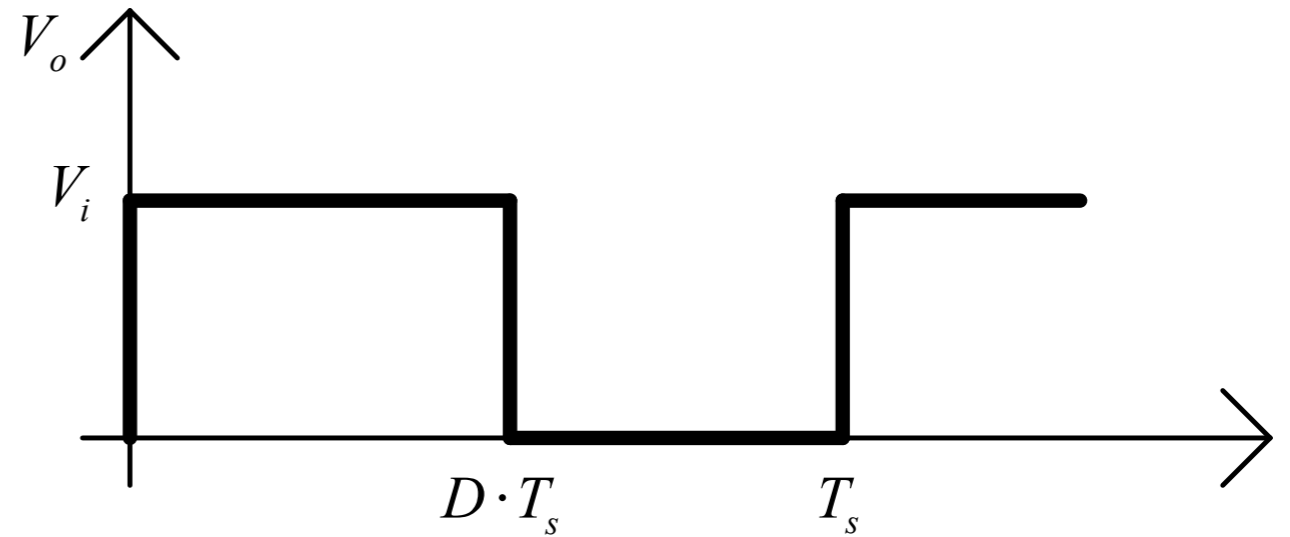
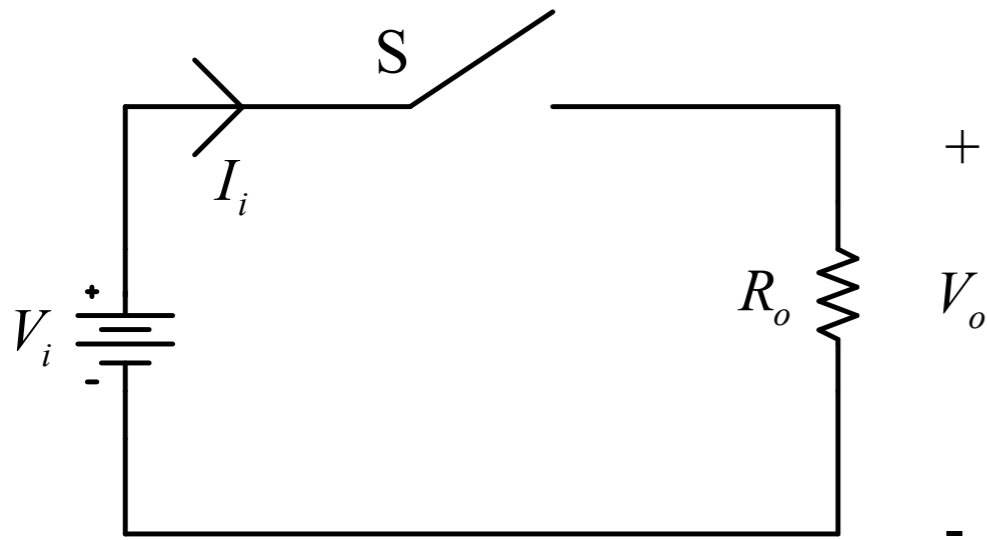

Tensão média na saída:

$$V_{med} = V_o = \frac{1}{T_s} [V_i \cdot D \cdot T_s]$$

$$T_{on} = D \cdot T_s$$

$$V_o = D \cdot V_i$$

$$D = \frac{V_o}{V_i}$$

Princípio Geral

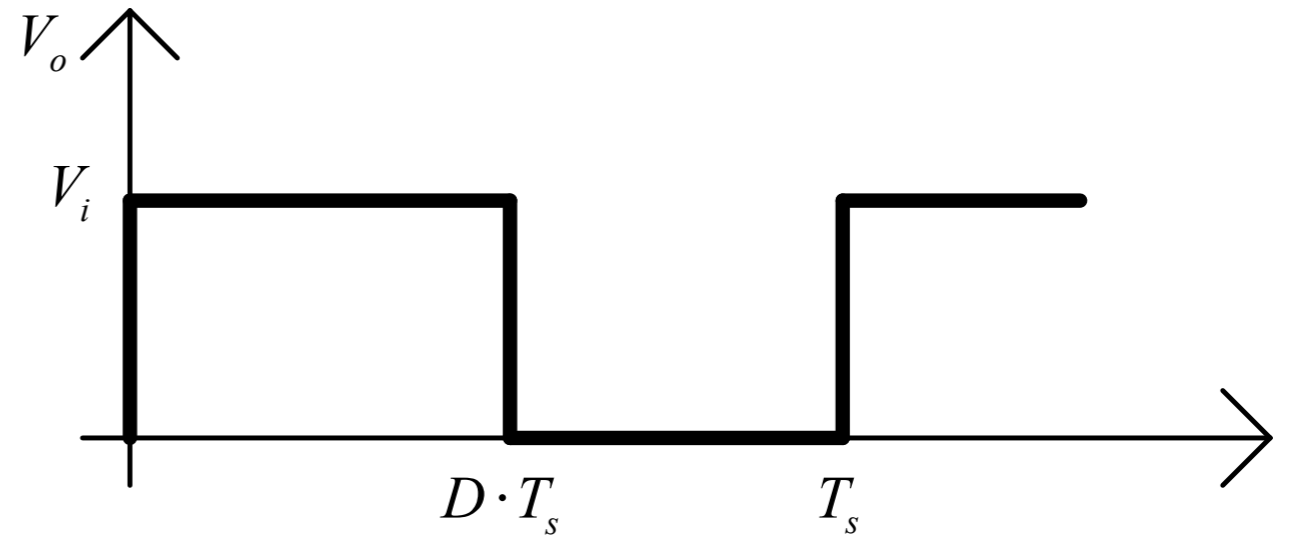
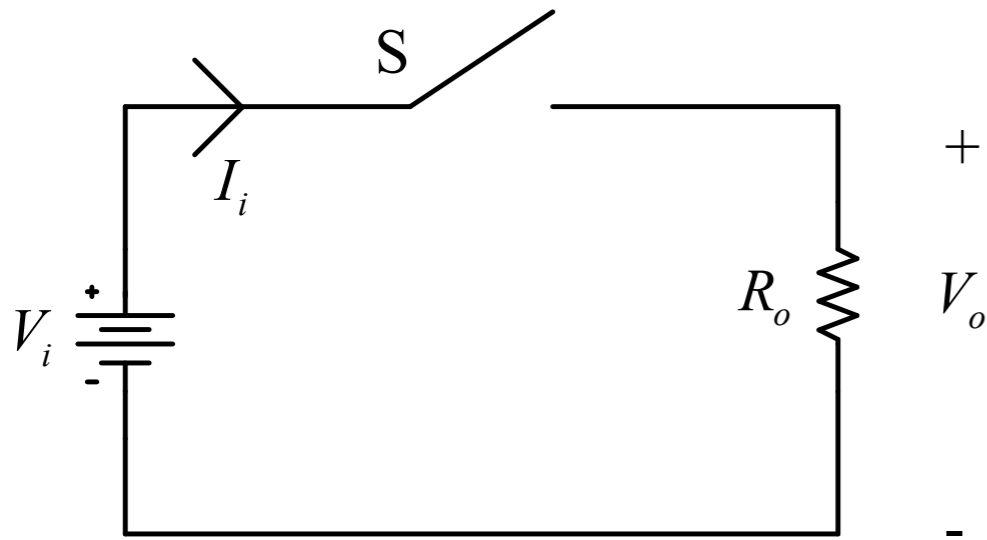

Ganho estático:

$$V_o = D \cdot V_i$$

$$D = \frac{V_o}{V_i}$$

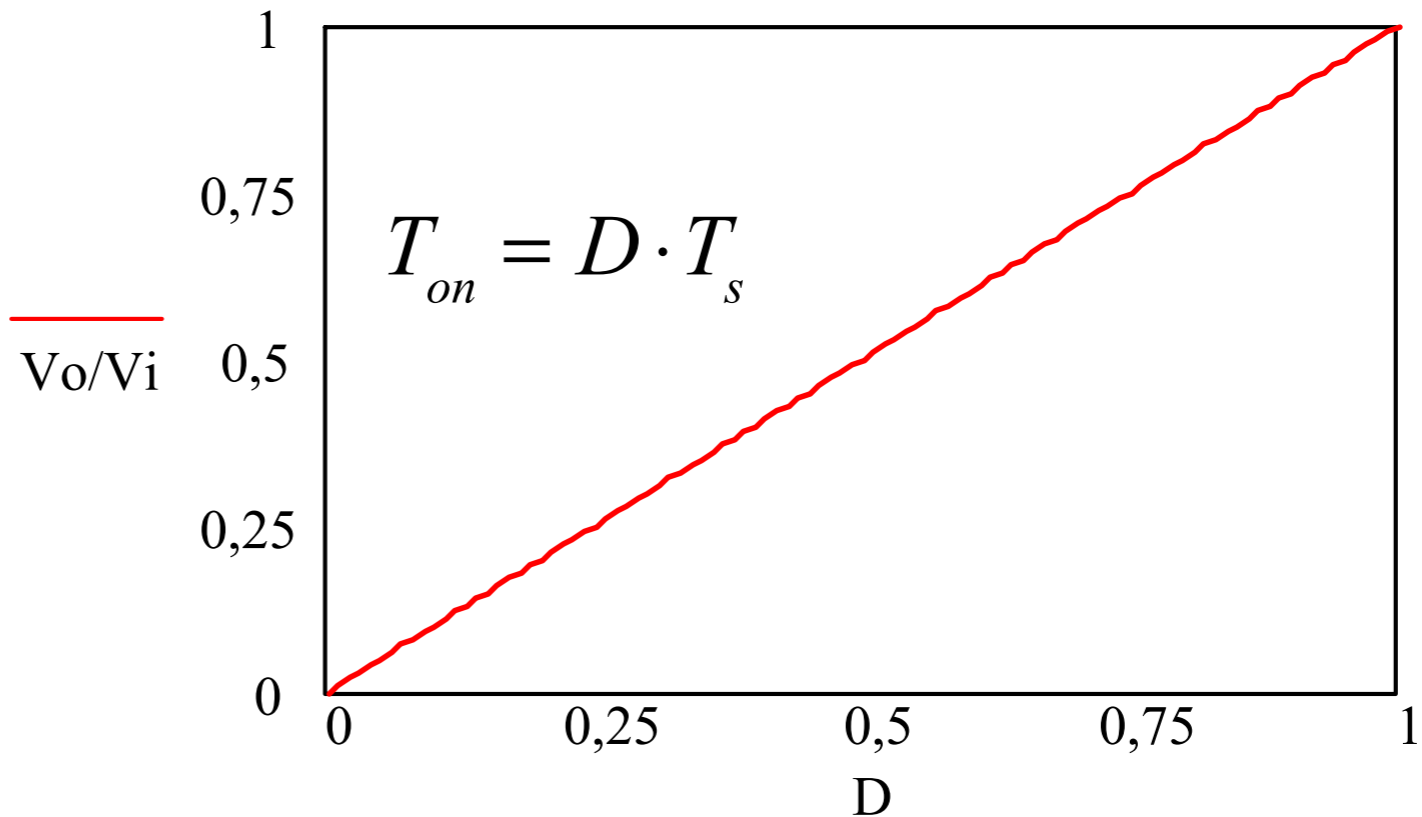

Princípio Geral

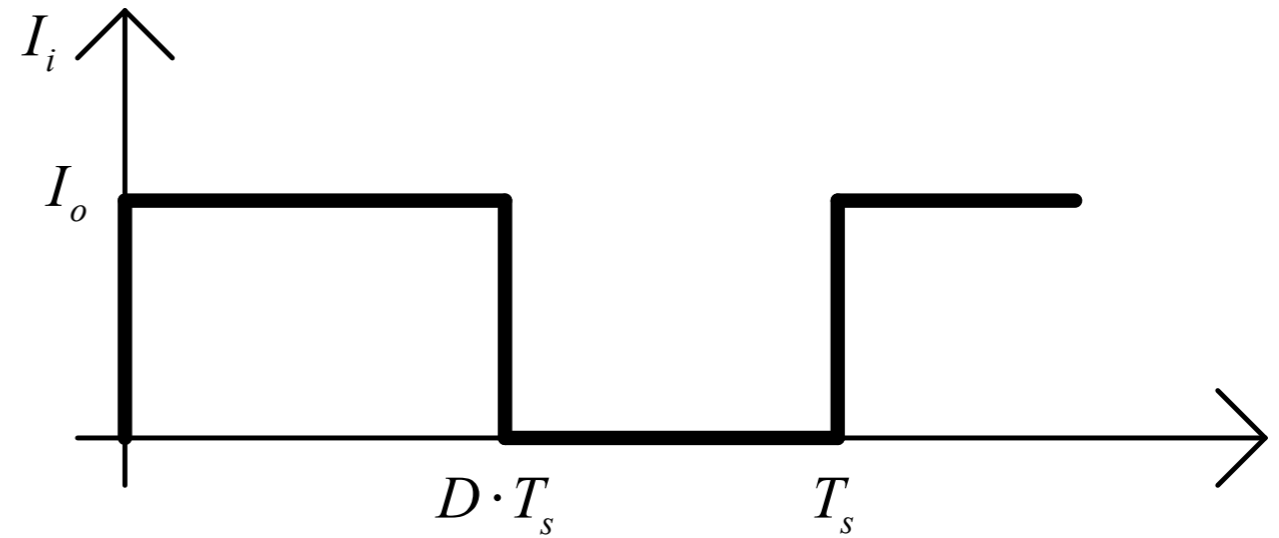
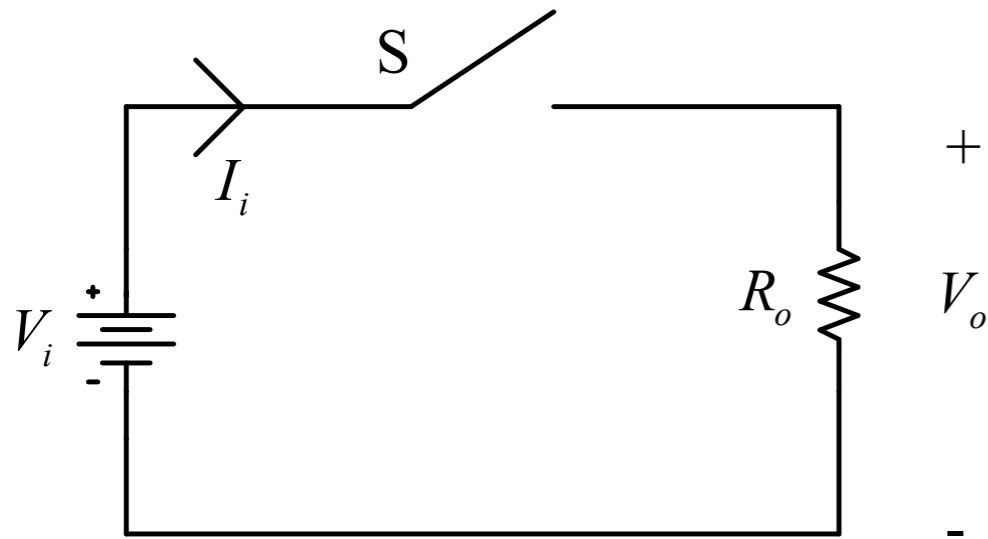

Corrente média na entrada:

$$I_{med} = I_i = \frac{1}{T_s} \cdot (I_o \cdot D \cdot T_s)$$

$$T_{on} = D \cdot T_s$$

$$I_i = D \cdot I_o$$

$$D = \frac{I_i}{I_o}$$

Princípio Geral

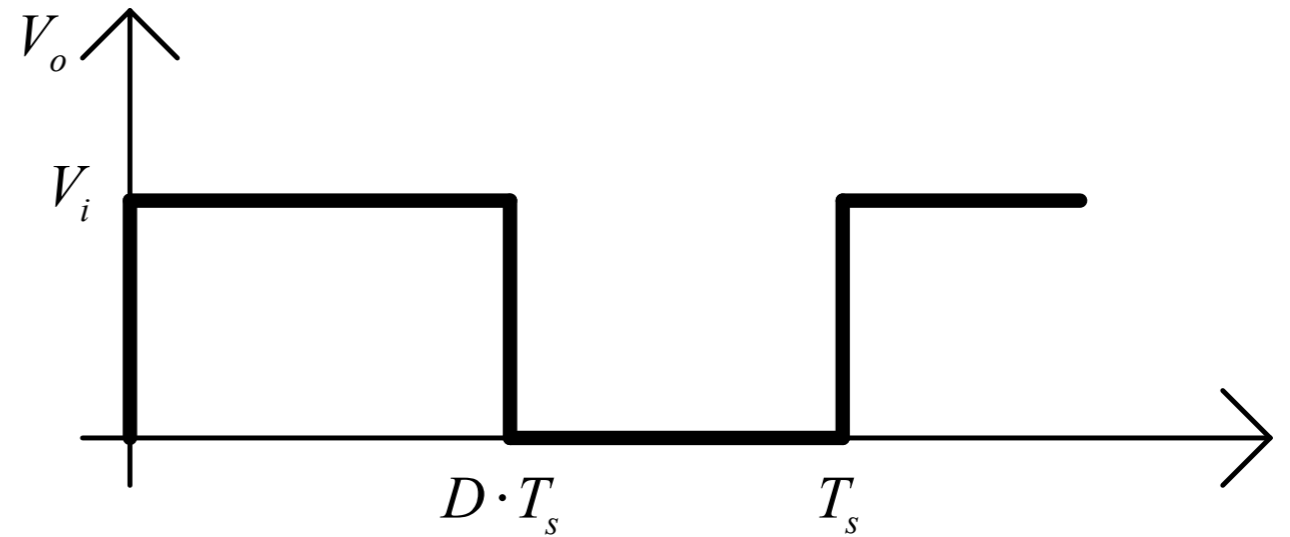
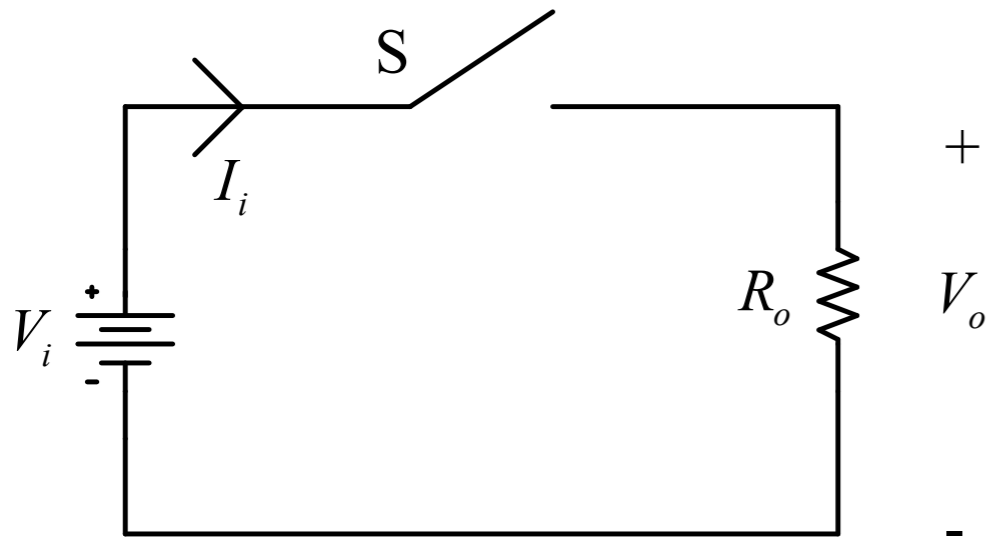

Potência na entrada e na saída:

$$P_i = V_i \cdot I_i$$

$$P_o = V_o \cdot I_o$$

$$P_i = \frac{P_o}{\eta}$$

$$P_i = P_o$$

$$V_i \cdot I_i = V_o \cdot I_o$$

$$\frac{V_i}{V_o} = \frac{I_o}{I_i}$$

Princípio Geral

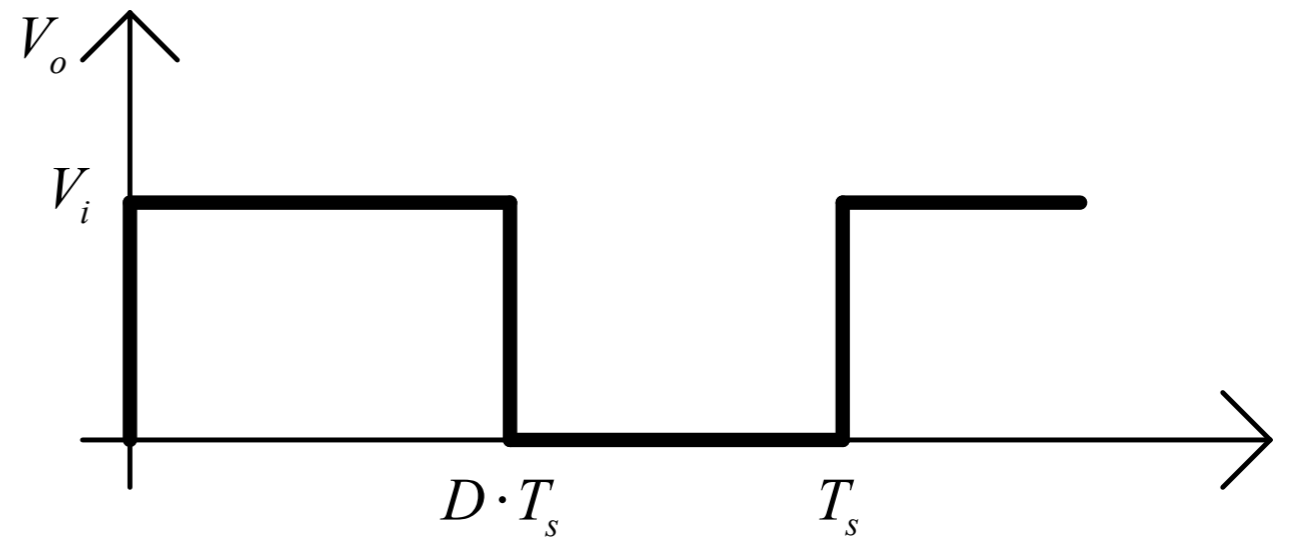
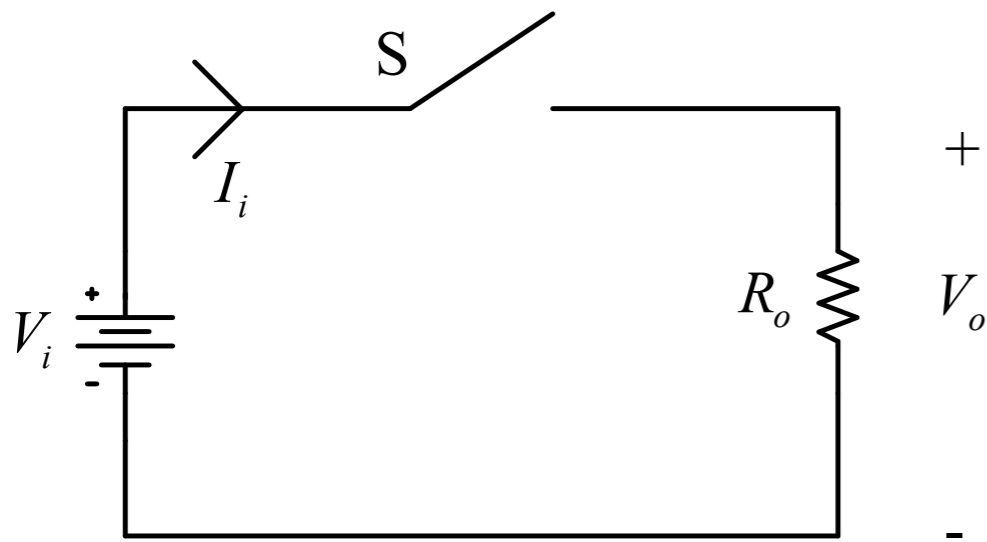

Como variar a tensão de saída?

- Alterando o tempo de condução e bloqueio (PWM);
- Alterando a frequência de comutação (PFM).

PWM:

- Modulação por largura de pulsos;
- Pulse Width Modulation.

PFM:

- Modulação por frequência variável;
- Pulse Frequency Modulation.

Princípio Geral

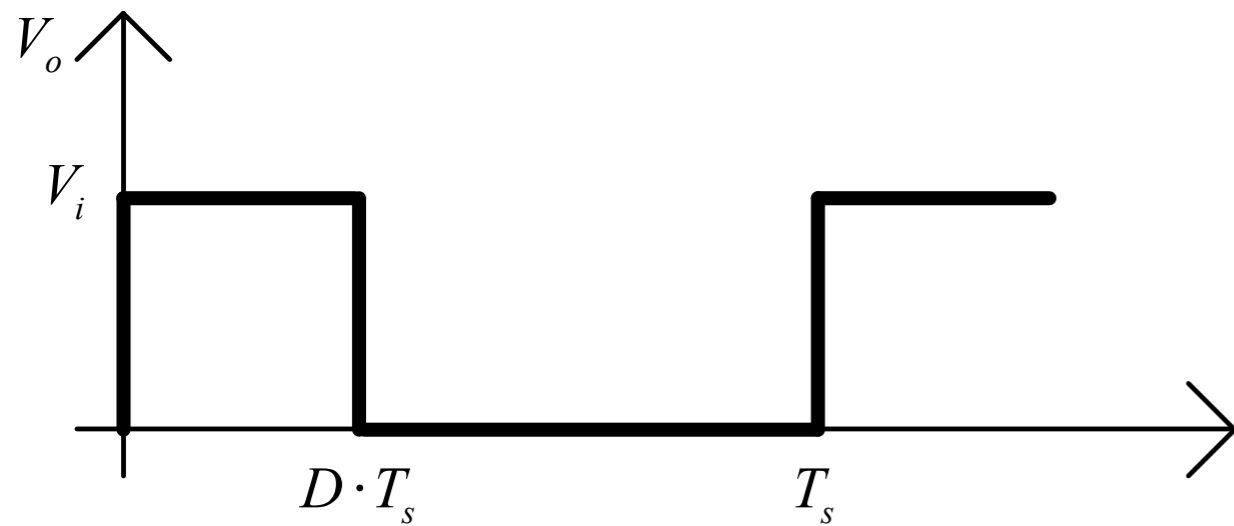
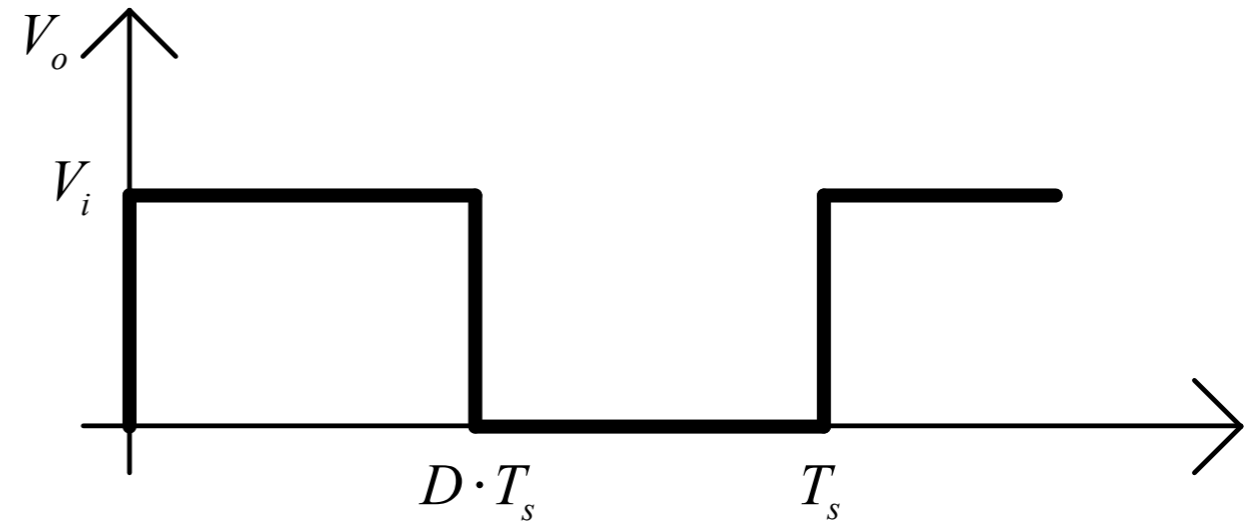
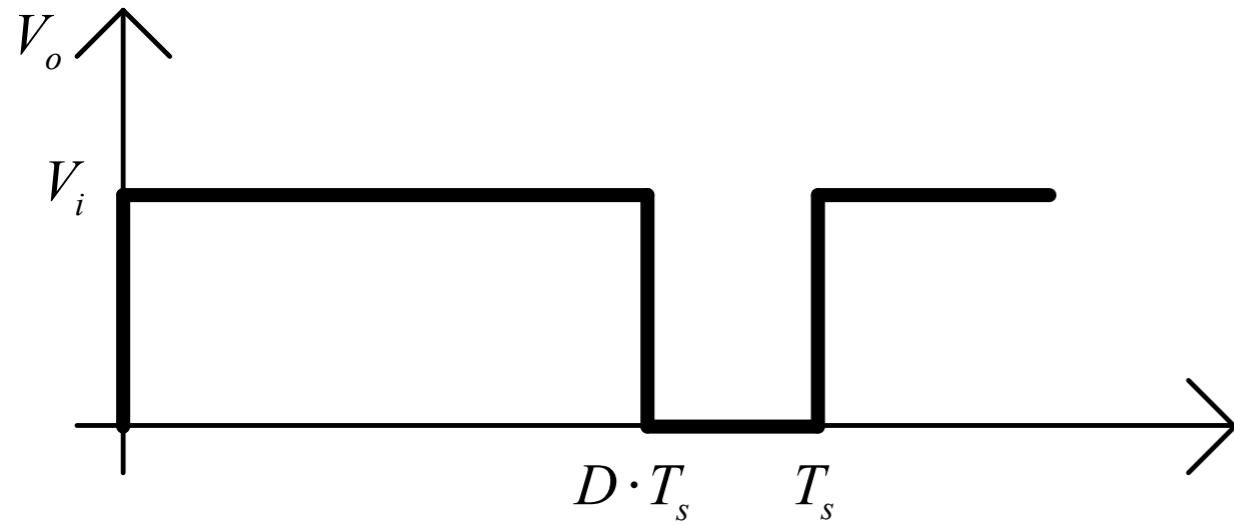

PWM

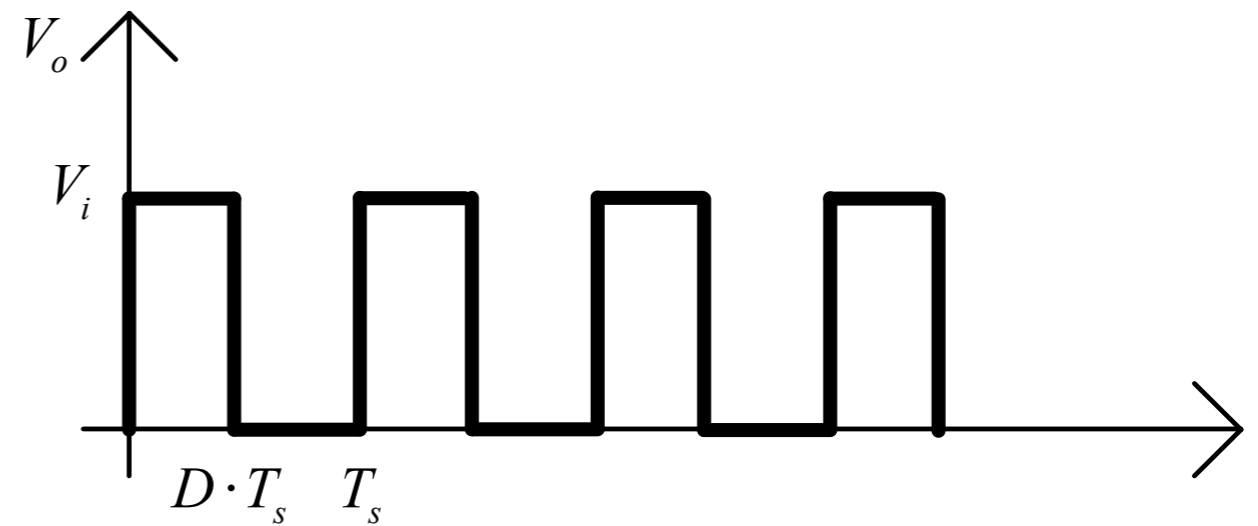

PFM

Demonstração

Demo

- Formas de onda do conversor simples.

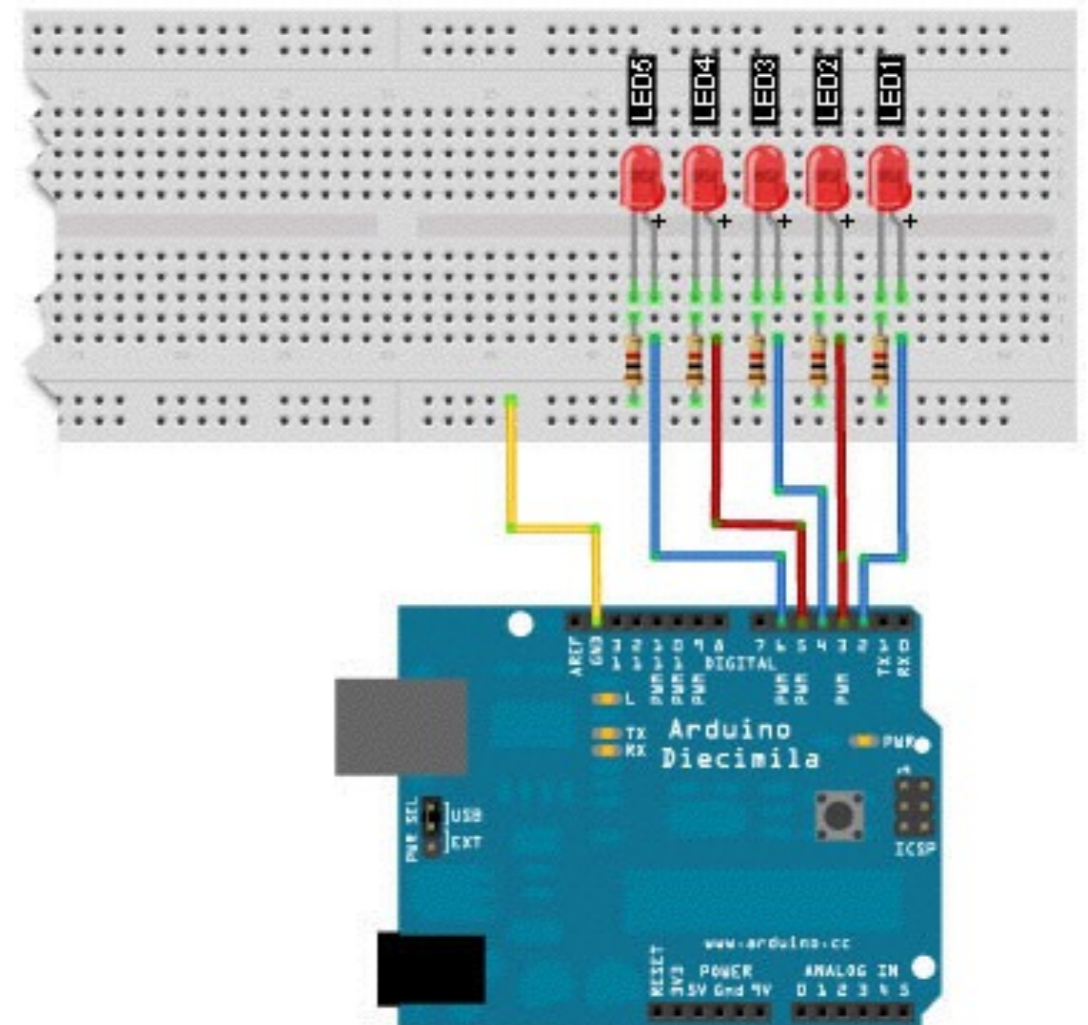

Tarefas

Exercício 1) Considerando o circuito abaixo, com tensão de entrada de 12 V, potência de saída de 5 W e tensão de saída de 5 V, determine:

- Razão cíclica de operação;
- Tensão máxima na saída;
- Corrente média na carga;
- Corrente média no interruptor;
- Corrente máxima no interruptor;
- Tensão máxima sobre o interruptor;
- Potência na fonte.

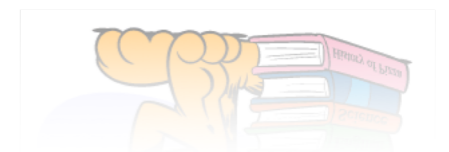

Conversores cc-cc:

- Conversor Buck.

