

Centro Federal de Educação Tecnológica de Santa Catarina
Departamento de Eletrônica
Retificadores



Aplicações dos diodos
Parte 4

Prof. Clóvis Antônio Petry.

Florianópolis, novembro de 2007.

Na próxima aula

Seqüência de conteúdos:

1. Aplicações de diodos (zener) – Parte 4.

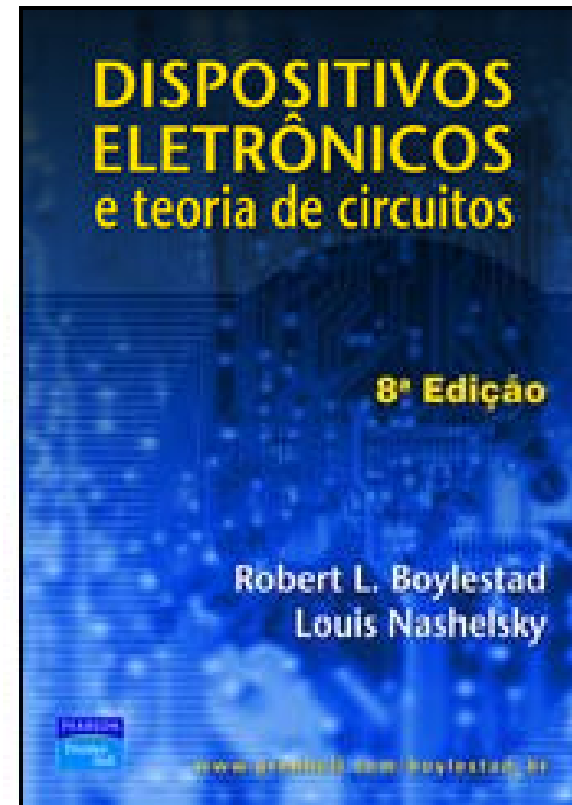

Nesta aula

Seqüência de conteúdos:

1. Diodos zener.

Diodos zener

Região de operação zener:

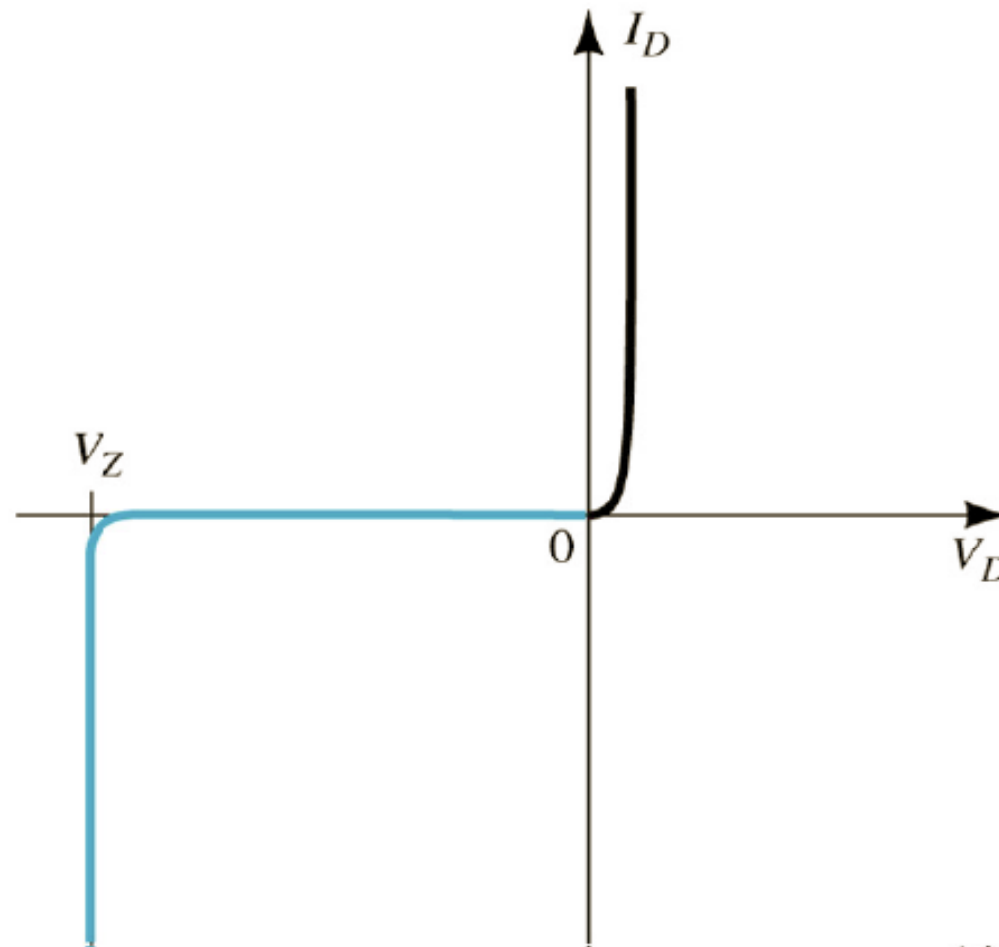

Diodos zener

Sentido de condução:

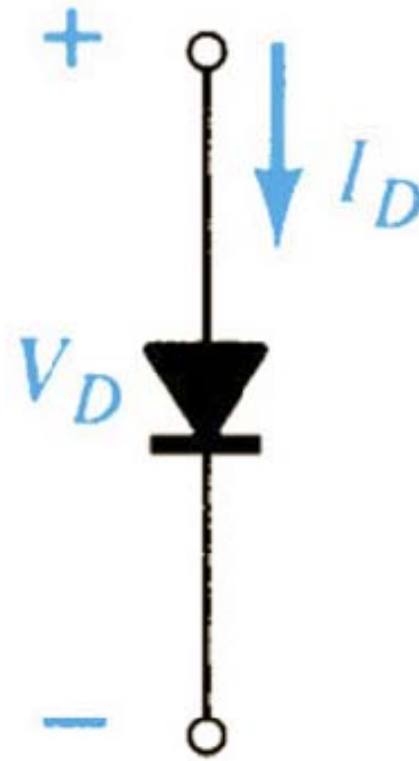
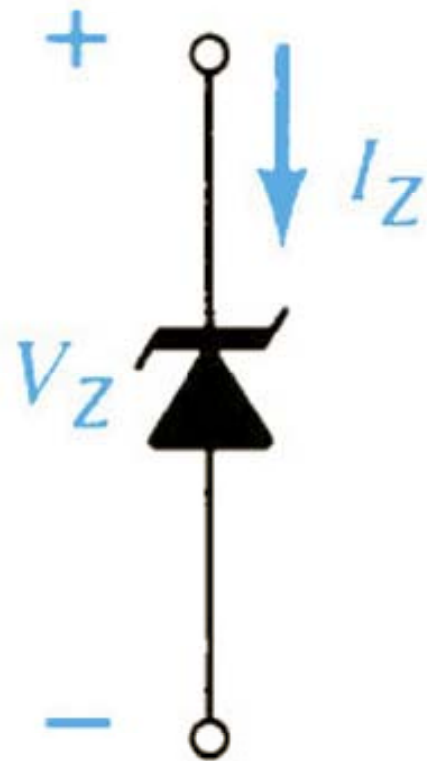

Diodos zener

Modelos equivalentes do diodo zener:

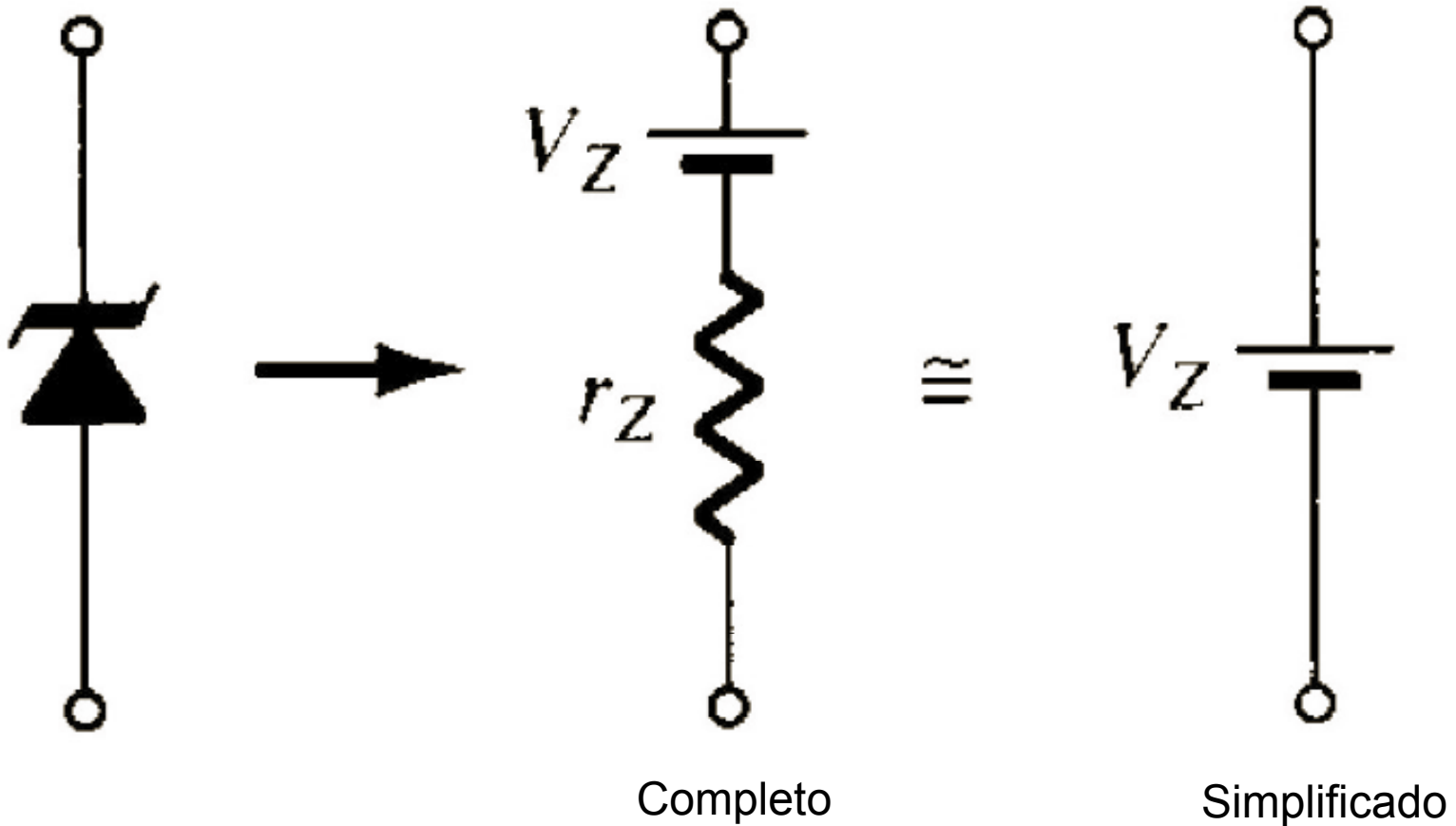

Diodos zener

Curva característica de um diodo zener:

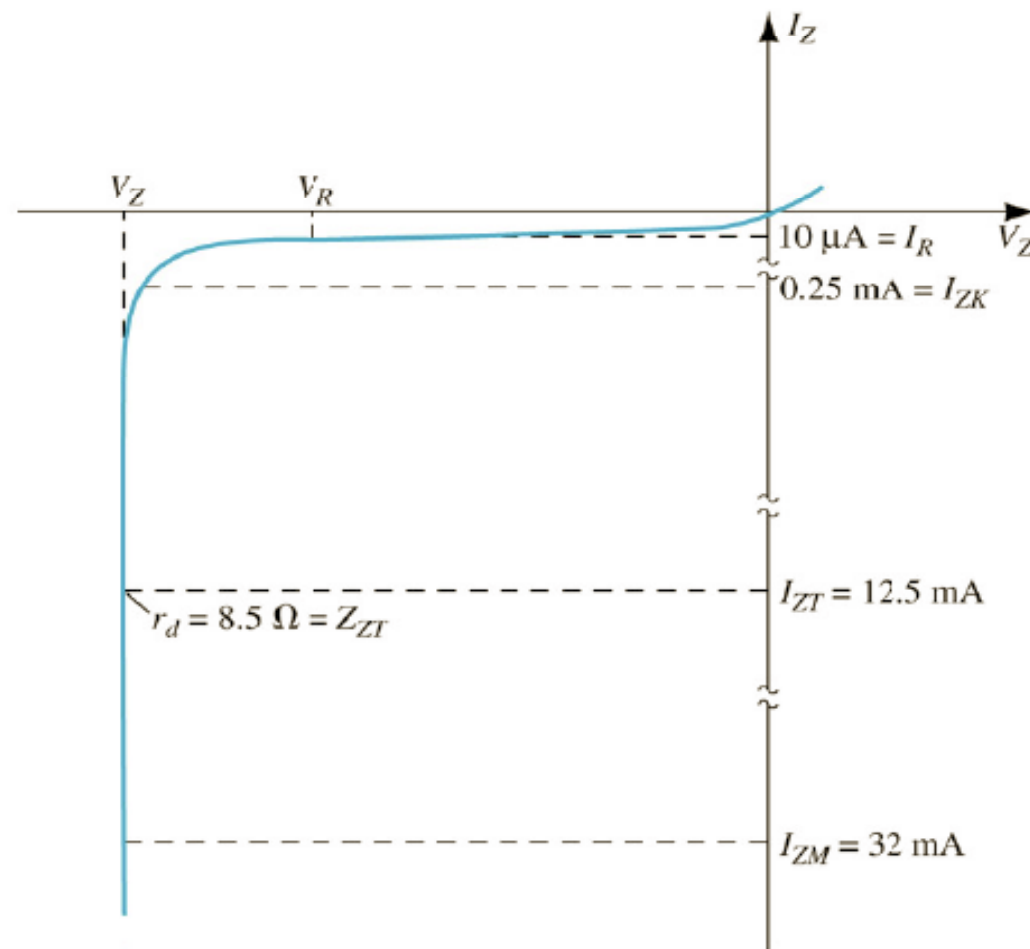

Diodos zener

Características elétricas:

- Tensão zener nominal – V_Z [V];
- Corrente de teste – I_{ZT} [mA];
- Impedância dinâmica – Z_{ZT} @ I_{ZT} [Ω];
- Corrente de joelho – I_{ZK} [mA];
- Impedância de joelho máxima – Z_{ZK} @ I_{ZK} [Ω];
- Corrente reversa máxima – I_R @ V_R [μ A];
- Tensão de teste – V_R [V];
- Corrente máxima de regulação – I_{ZM} [mA];
- Coeficiente de temperatura típico - %/ $^{\circ}$ C.

Diodos zener

Coeficiente de temperatura versus corriente zener:

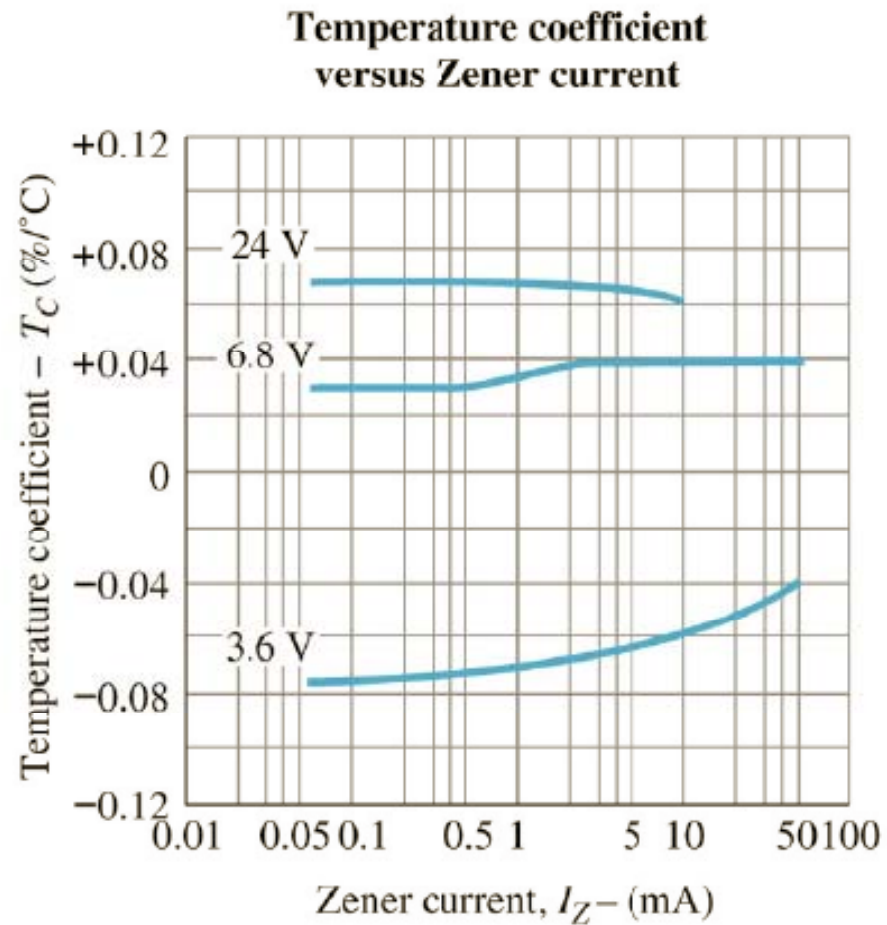

Diodos zener

Impedância dinâmica versus corrente zener:

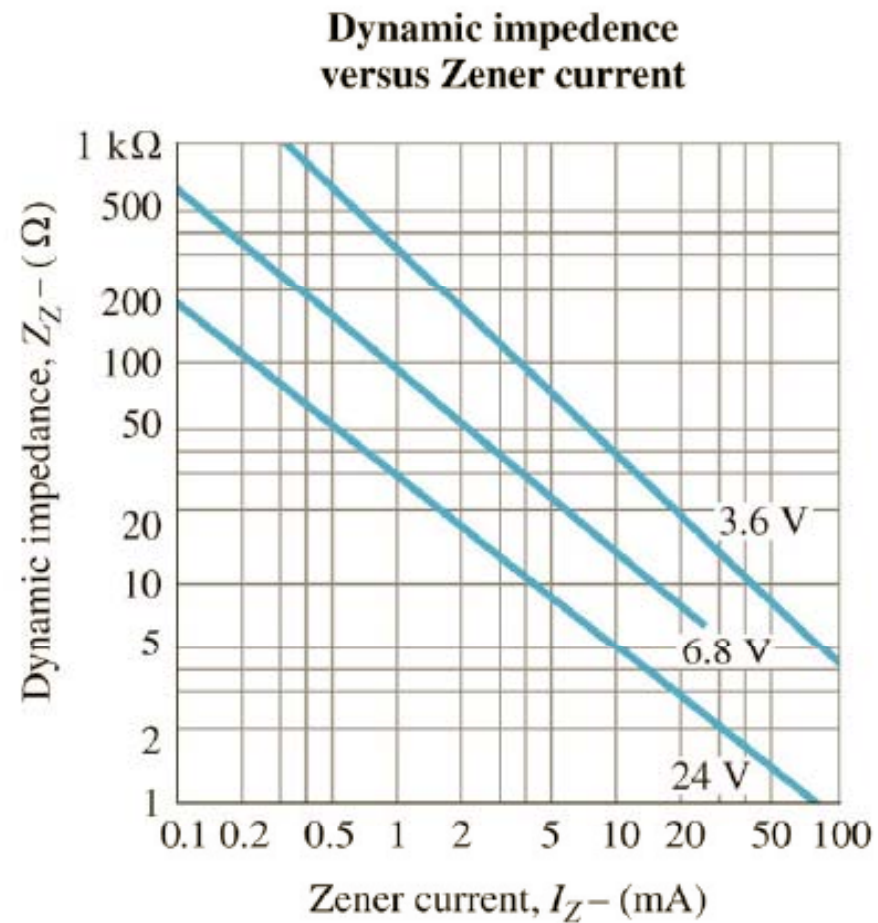

Diodos zener

Aspectos de diodos zener:

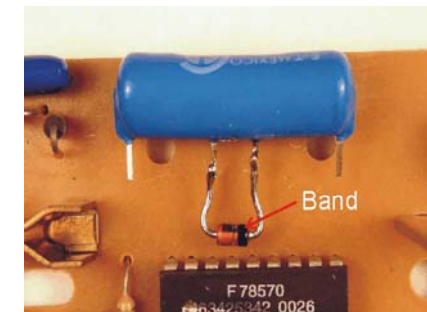
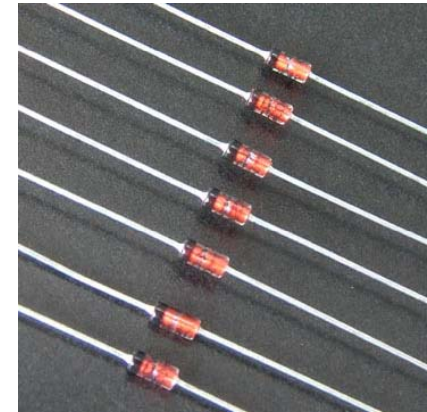
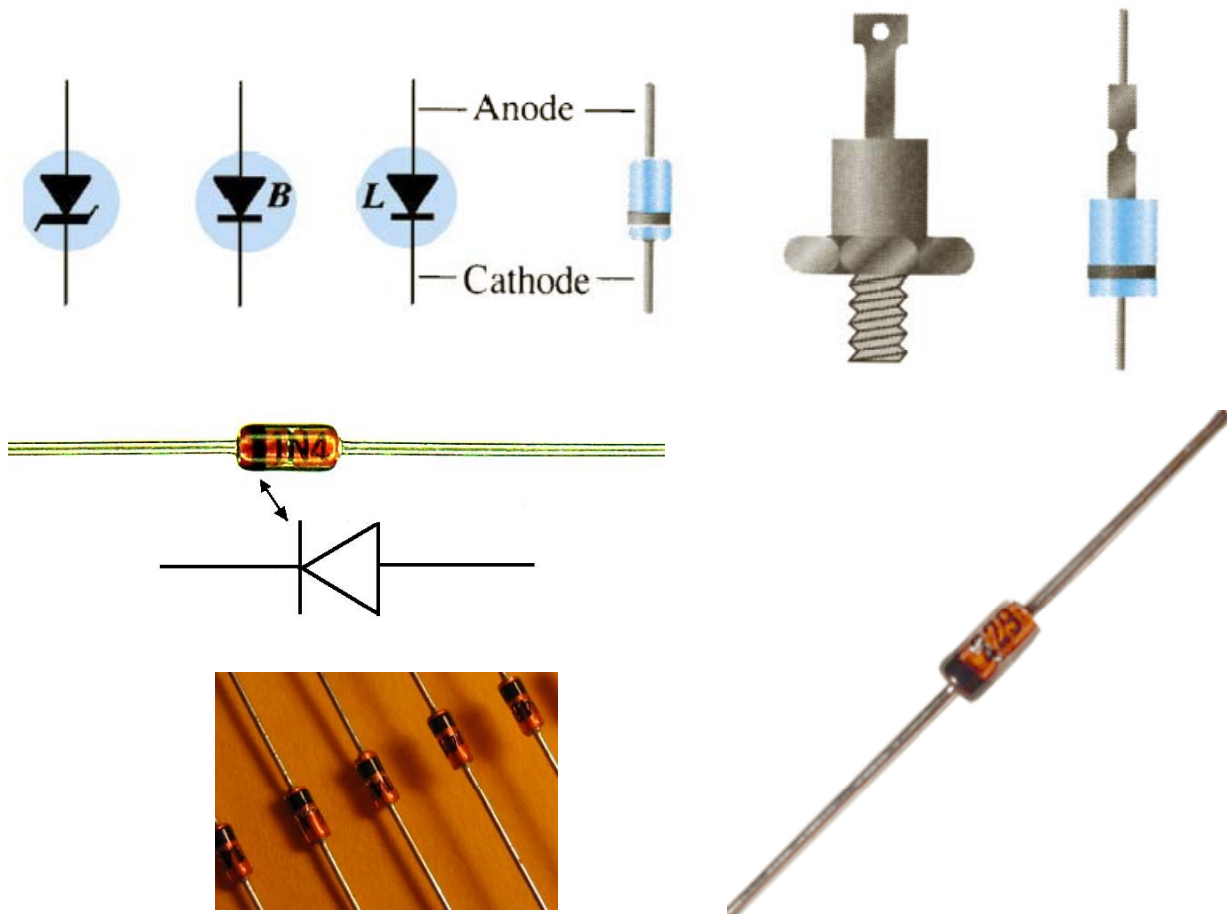

Diodos zener

Regulador zener:

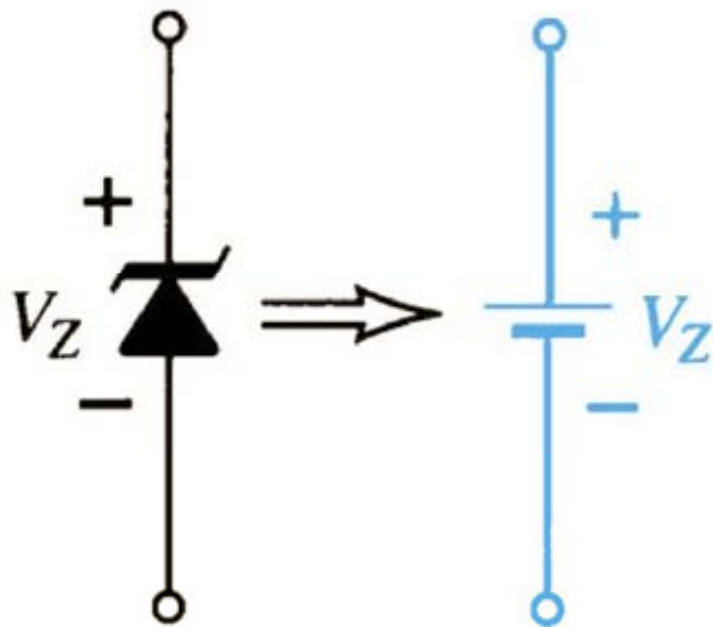

"on"

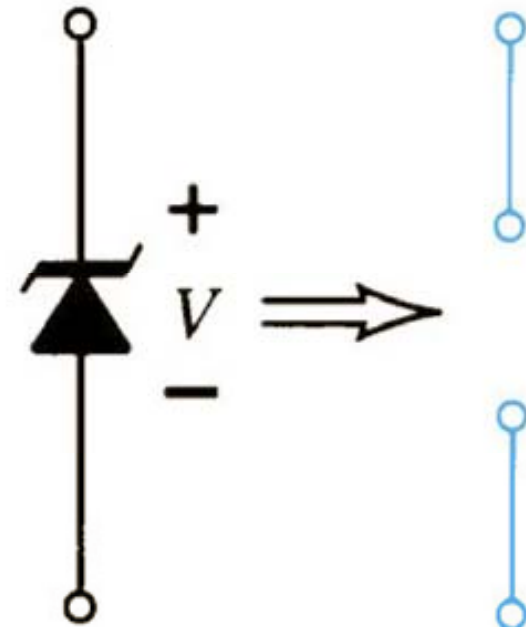

$(V_Z > V > 0 \text{ V})$

"off"

Comportamento do zener em condução e bloqueado.

Diodos zener

Circuito regulador zener básico: V_i e R_L fixos

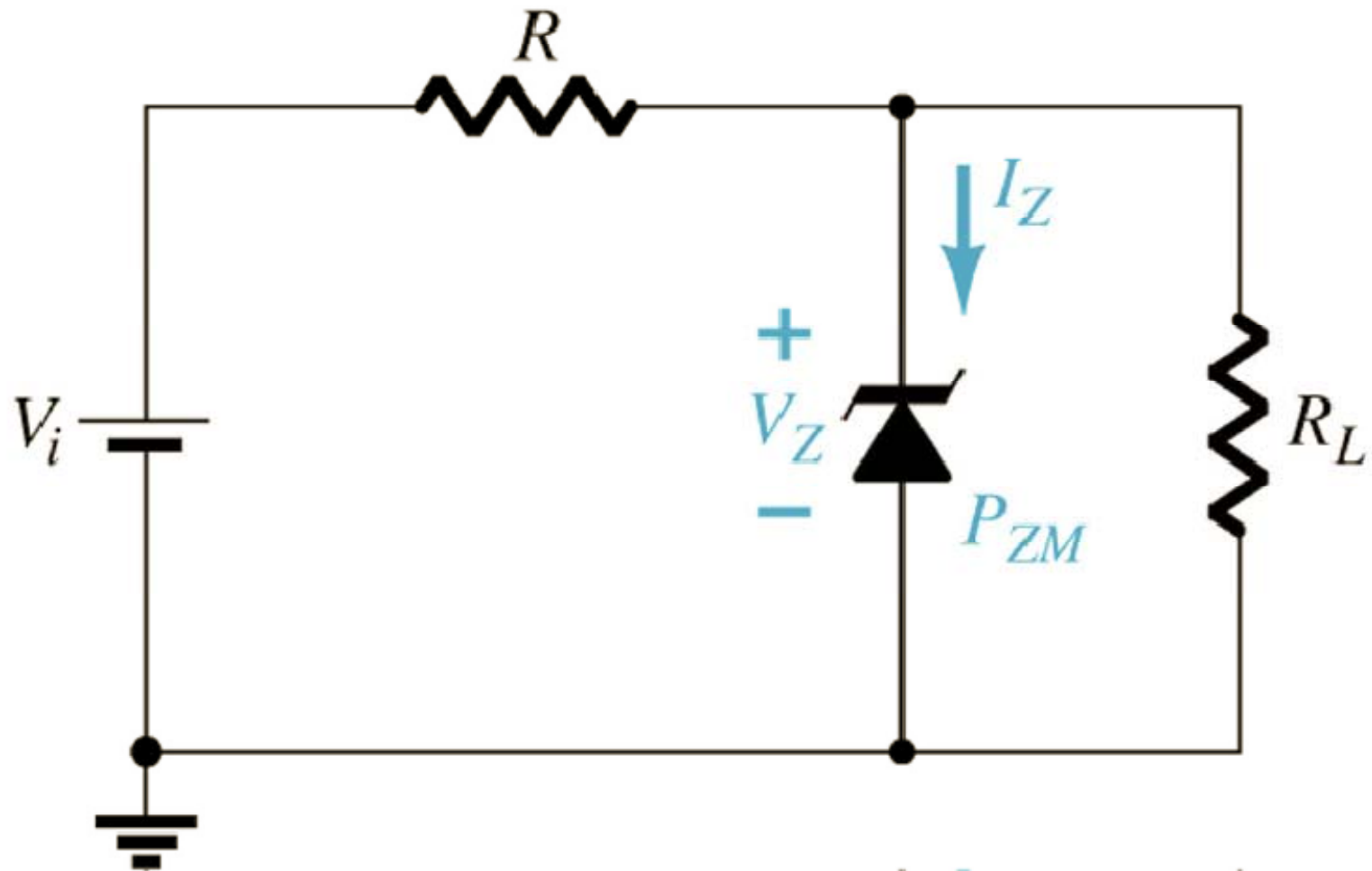

Diodos zener

Circuito regulador zener básico: V_i e R_L fixos

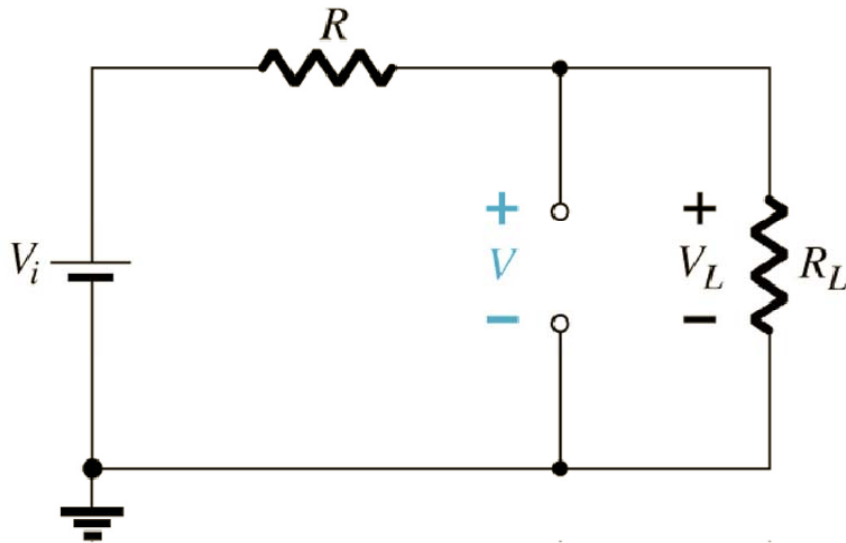

$$V = V_L = \frac{R_L \cdot V_i}{R + R_L}$$

$$V_L = V_Z$$

Para verificar se o zener está ligado, retira-se o mesmo do circuito e calcula-se a tensão sobre o zener. Se a tensão for maior que a tensão zener, ele estará ligado.

→ $V_L \geq V_Z$

Diodos zener

Circuito regulador zener básico: V_i e R_L fixos

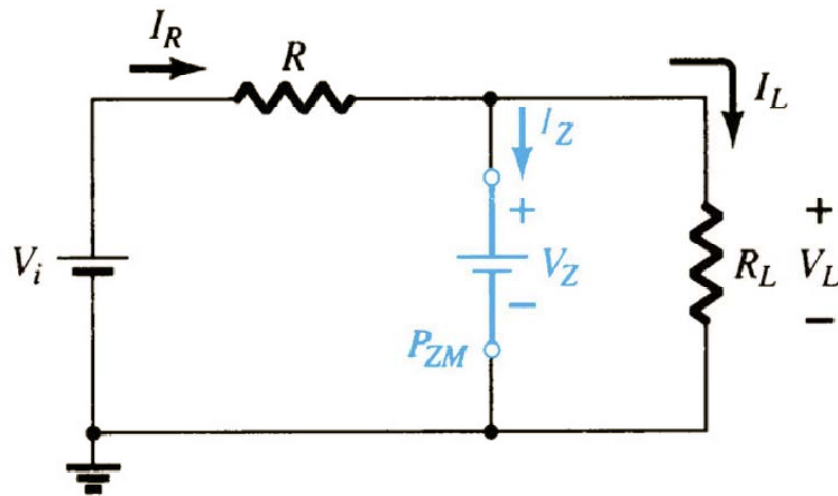

Se:

$$V_L \geq V_Z$$

$$I_R = I_Z + I_L$$

$$I_Z = I_R - I_L$$

$$I_L = \frac{V_L}{R_L} \quad I_R = \frac{V_R}{R} = \frac{V_i - V_L}{R}$$

$$P_Z = V_Z \cdot I_Z$$

Diodos zener

Circuito regulador zener básico, exemplo:

V_i e R_L fixos

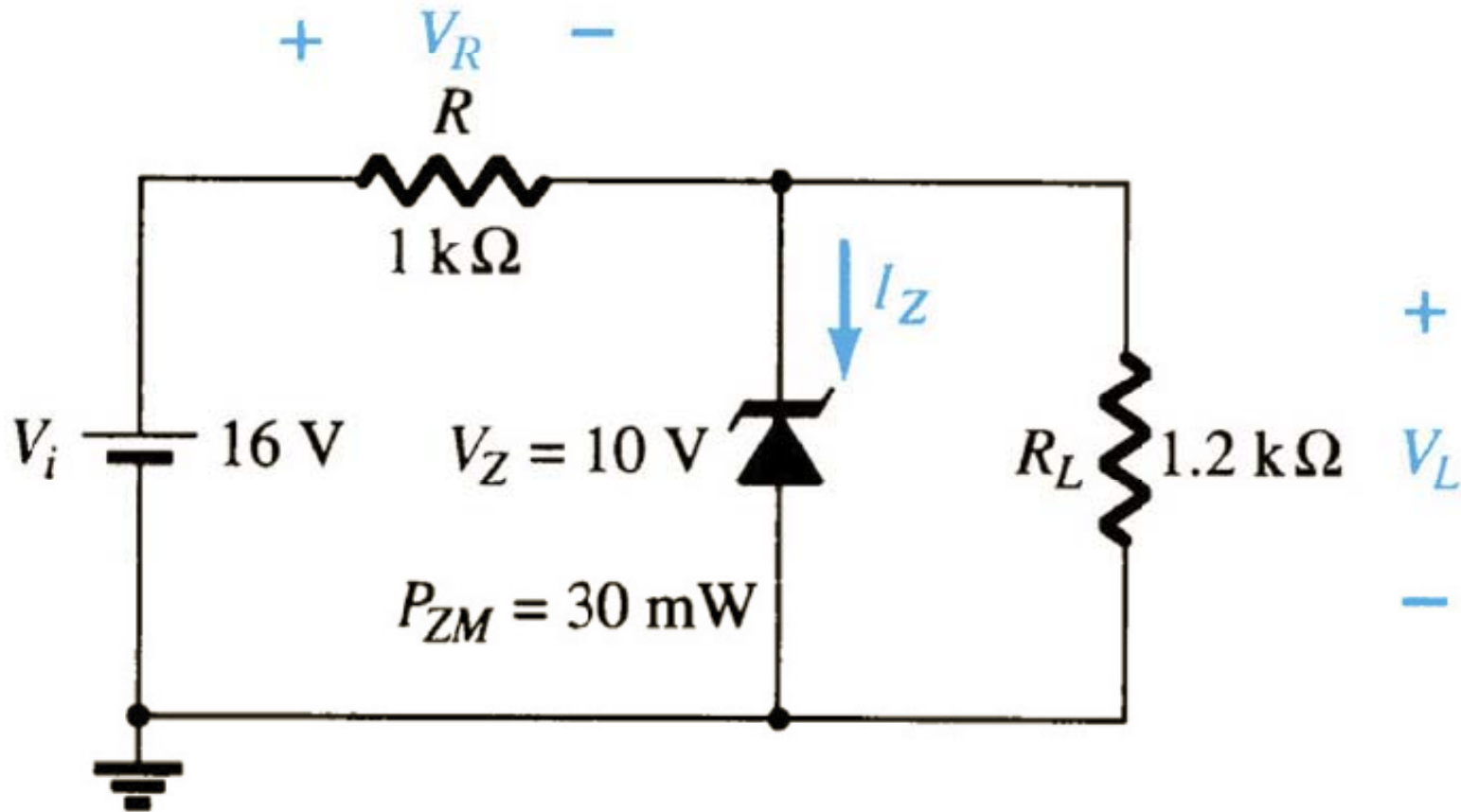

Diodos zener

Circuito regulador zener básico, exemplo:

V_i e R_L fixos

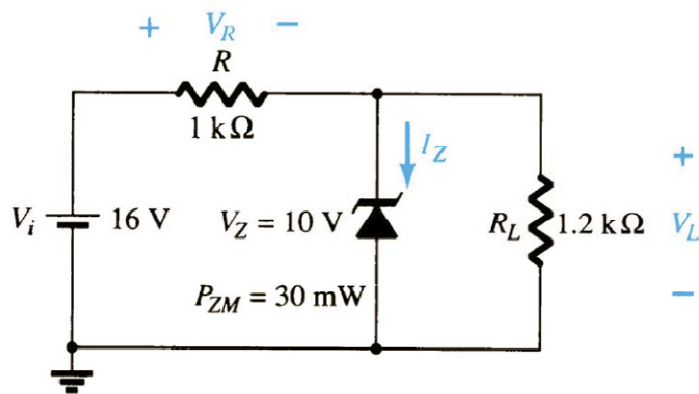

Como:

$$8,73 < 10$$

$$V_L < V_Z$$

O diodo está bloqueado.

$$V = \frac{R_L \cdot V_i}{R + R_L} = \frac{1,2k \cdot 16}{1k + 1,2k} = 8,73V$$

$$V_L = V = 8,73V$$

Diodos zener

Circuito regulador zener básico, exemplo: V_i e R_L fixos

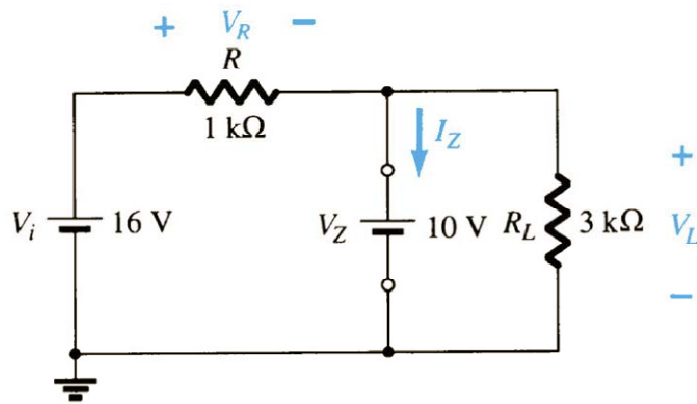

$$V = \frac{R_L \cdot V_i}{R + R_L} = \frac{3k \cdot 16}{1k + 3k} = 12V$$

$$V_L = V = 12V$$

Como: $12 > 10$

O diodo está conduzindo.

$$V_R = V_i - V_L = 16 - 10 = 6V$$

$$I_L = \frac{V_L}{R_L} = \frac{10}{3k} = 3,33mA$$

$$I_R = \frac{V_R}{R} = \frac{6}{1k} = 6mA$$

$$I_Z = I_R - I_L = 6m - 3,33m$$

$$I_Z = 2,67mA$$

$$P_Z = V_Z \cdot I_Z = 10 \cdot 2,67m = 26,7mW$$

Diodos zener

Circuito regulador zener básico: V_i fixo e R_L variável

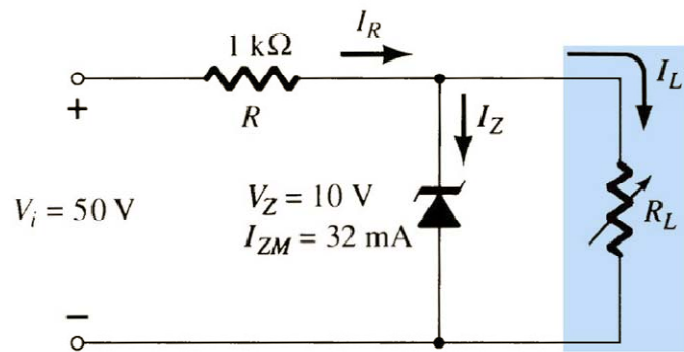

$$V_L = V_Z = \frac{R_L \cdot V_i}{R + R_L}$$

$$R_{Lmin} = \frac{R \cdot V_Z}{V_i - V_Z}$$

$$I_{Lmax} = \frac{V_L}{R_L} = \frac{V_Z}{R_{Lmin}}$$

$$V_R = V_i - V_Z$$

$$I_R = \frac{V_R}{R}$$

$$I_Z = I_R - I_L$$

$$I_{Lmin} = I_R - I_{ZM}$$

$$R_{Lmax} = \frac{V_Z}{I_{Lmin}}$$

Diodos zener

Circuito regulador zener básico, exemplo: V_i fixo e R_L variável

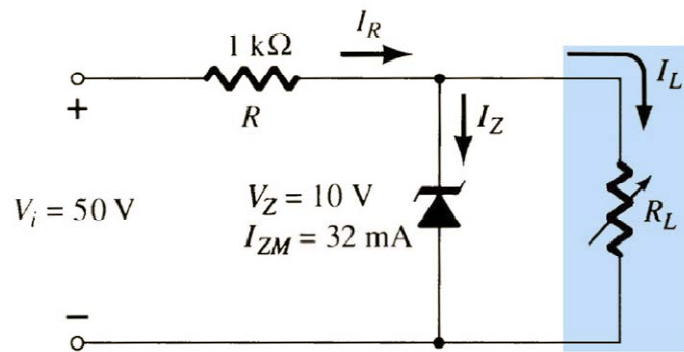

$$R_{Lmin} = \frac{R \cdot V_Z}{V_i - V_Z} = \frac{1k \cdot 10}{50 - 10} = 250\Omega$$

$$V_R = V_i - V_Z = 50 - 10 = 40V$$

$$I_R = \frac{V_R}{R} = \frac{40}{1k} = 40mA$$

$$I_{Lmin} = I_R - I_{ZM} = 40m - 32m = 8mA$$

$$R_{Lmax} = \frac{V_Z}{I_{Lmin}} = \frac{10}{8m} = 1,25k\Omega$$

$$P_{max} = V_Z \cdot I_Z = 10 \cdot 32m = 320mW$$

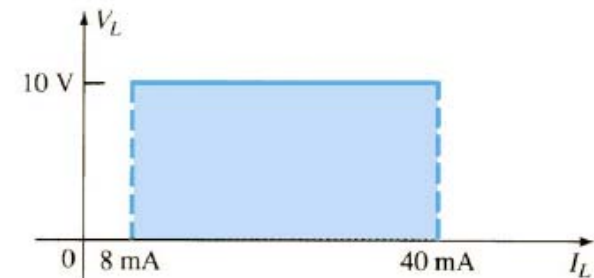
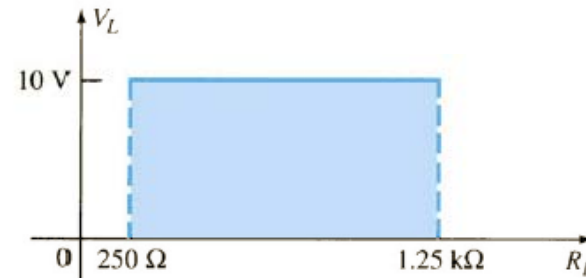

Diodos zener

Circuito regulador zener básico: V_i variável e R_L fixo

$$V_L = V_Z = \frac{R_L \cdot V_i}{R + R_L}$$

$$V_{imin} = \frac{(R_L + R) \cdot V_Z}{R_L}$$

$$I_{Rmax} = I_{ZM} + I_L$$

$$V_{imax} = I_{Rmax} \cdot R + V_Z$$

Diodos zener

Circuito regulador zener básico, exemplo: V_i variável e R_L fixo

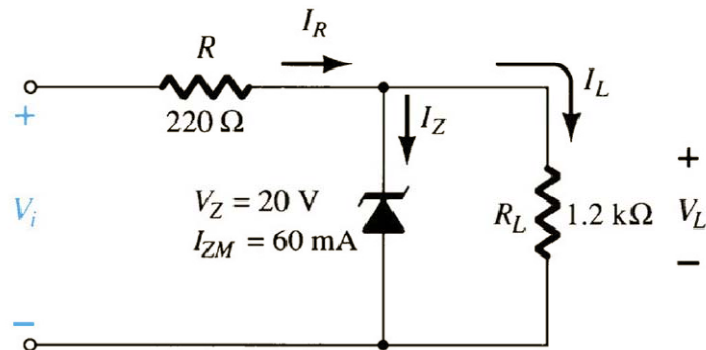

$$V_{imin} = \frac{(R_L + R) \cdot V_Z}{R_L} = \frac{(1200 + 220) \cdot 20}{1200} = 23,67V$$

$$I_L = \frac{V_L}{R_L} = \frac{V_Z}{R_L} = \frac{20}{1,2k} = 16,67 mA$$

$$I_{Rmax} = I_{ZM} + I_L = 60m + 16,67m = 76,67 mA$$

$$V_{imax} = I_{Rmax} \cdot R + V_Z = 76,67m \cdot 0,22k + 20 = 36,87V$$

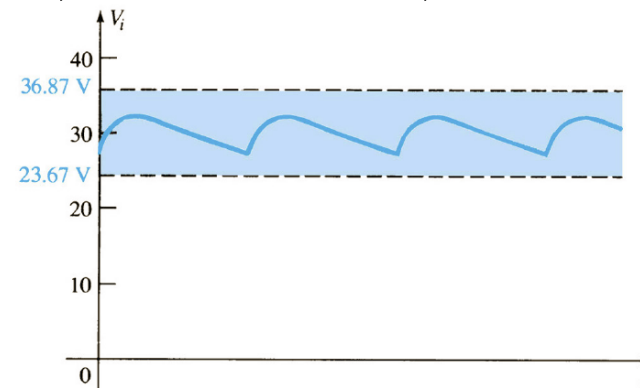
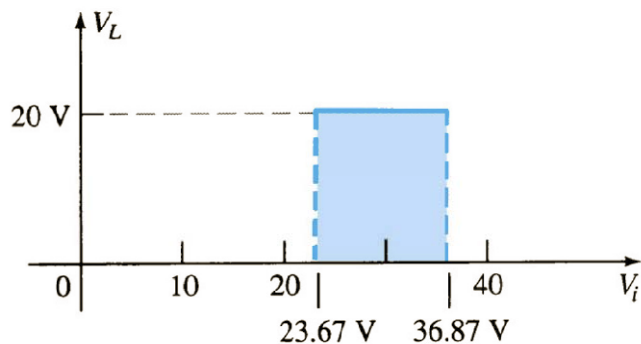

Na próxima aula

Seqüência de conteúdos:

1. Laboratório de aplicações de diodos.

